

Automation upgrade

Pandion EDA -> eAir

Warning!

According to regulations, an ordinary electricity consumer is only allowed to perform some minor service tasks.

According to Finnish regulations, a list of the allowed tasks can be found at the Tukes home page (www.tukes.fi).

Always make sure that the power supply is turned off before opening the service door.

Wait two minutes before beginning the maintenance work. The fans rotate for some time by themselves, and the heating element may be hot even if the power supply of the ventilation unit is switched off. Electrical housing may be opened only by a trained electrician.

Electrical installations must comply with local regulations.

Continuously check and compare the electrical diagrams at the end of this instruction as the upgrade progresses!

Table of contents

| | |
|--------------------------------|----|
| Upgrade..... | 3 |
| Electrical diagrams EDA | 25 |
| Electrical diagrams eAir | 29 |
| Parts list eAir E..... | 33 |
| Parts list eAir W..... | 34 |
| Notes | 35 |

Open **the small door (1)** by pressing on it.



Disconnect **the power cable (2)**
(+ other possible power supplies if available).



Open the service door by turning **the three locks (3)**.



Remove **the cover to the electrical box (1)** and **the supply air fan chamber (1)** by removing the screws.

NOTE! Ensure that no voltage is occurring in the electrical box before proceeding!

Remove **the POP rivets** from **the cable rail (2)** by drilling, and remove the cover.

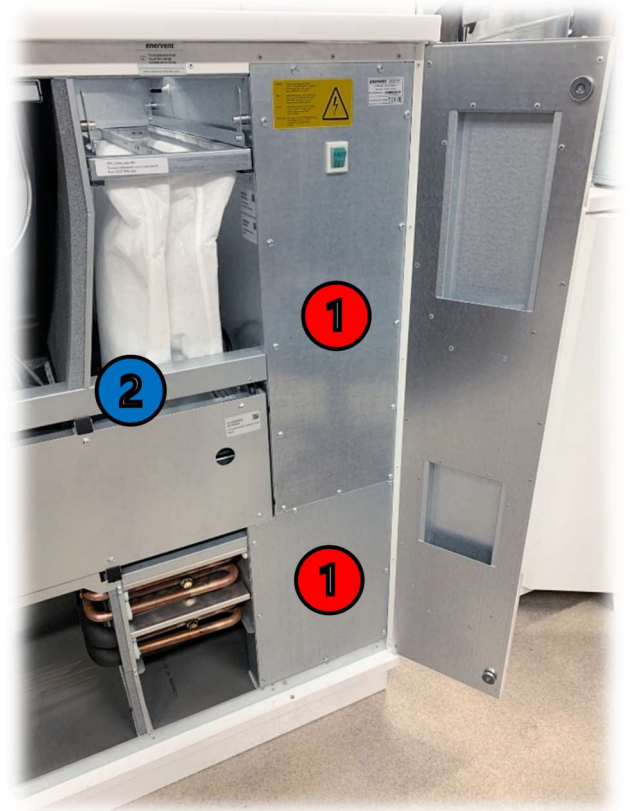

Remove **the filters (1)** by pulling.
Disconnect **the connectors (2)**.
Remove **the fans (3)**.

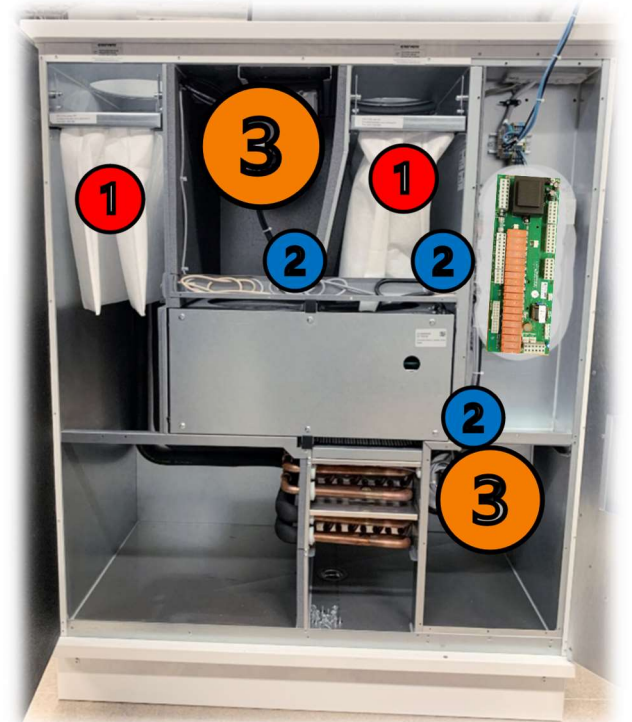

Mark all wires/sensors according to the marking on the main board and disconnect them from **the EDA main board (1)**.

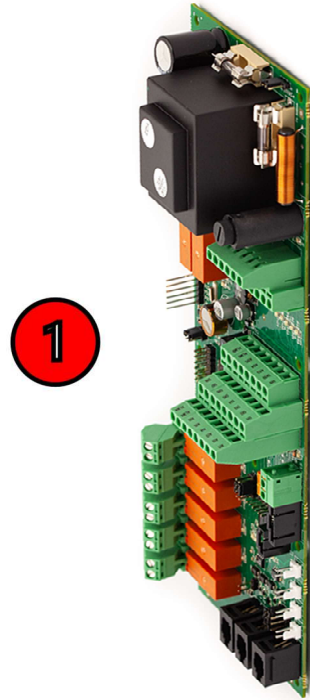

Mark all wires according to the marking on the circuit board and disconnect them from **the HRW circuit board (2)** and **possible transformer (3)**.
Type of HRW depends on year of manufacture.

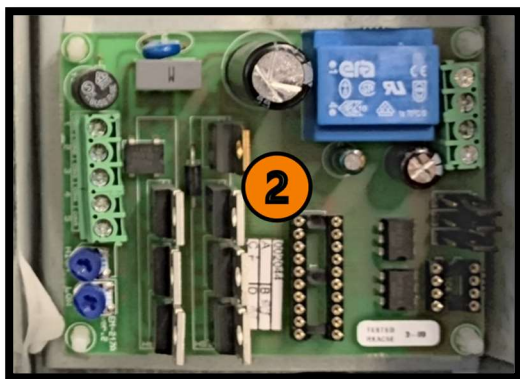

AC HRW circuit board.

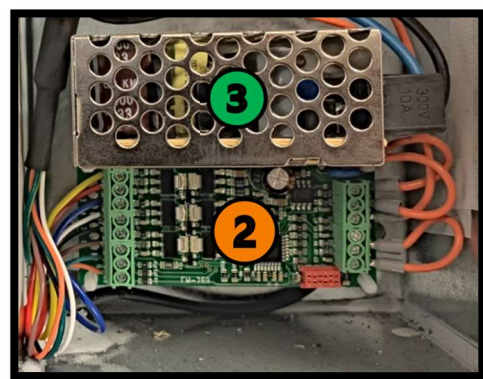

DC HRW circuit board.

Disconnect **all ground wires (1)** from the automation base ground point.

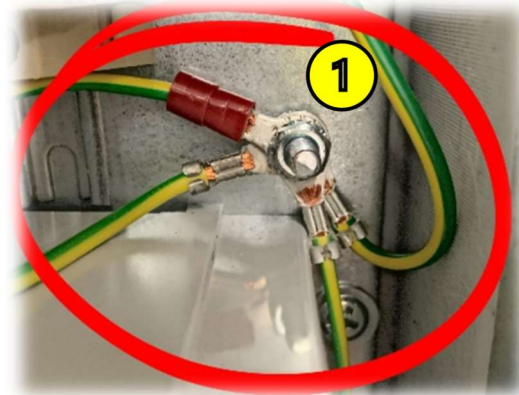

Disconnect the main power cable from **the terminals (7)** and from **the main switch**.

Remove **the screws (3)** and remove the automation base incl. **terminals (7)**, **relay board (4)**, **EDA main board (5)**, **capacitors (6)** and **transformer (2)**.

If there is a **blue relay (8)** installed, remove the relay along with the wires and replace the electrical after heater with the new delivered one.

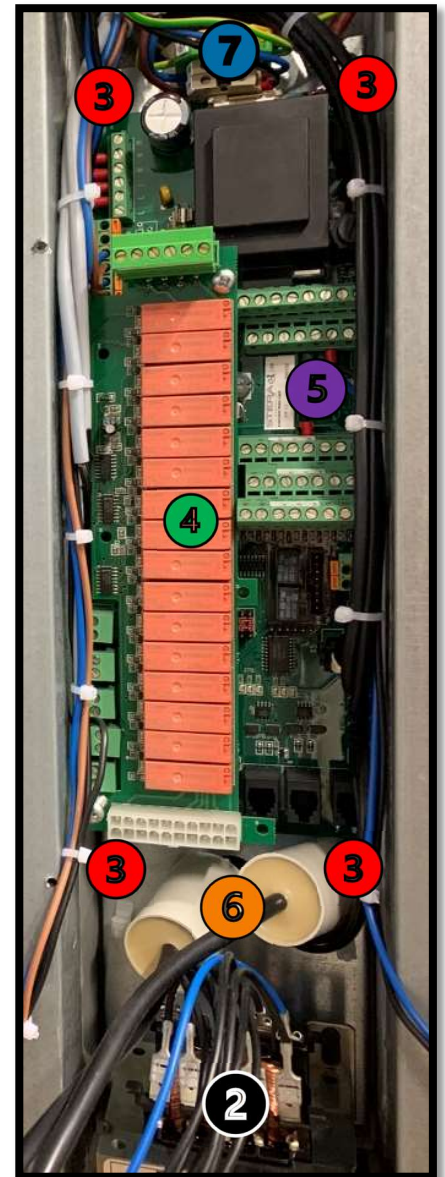
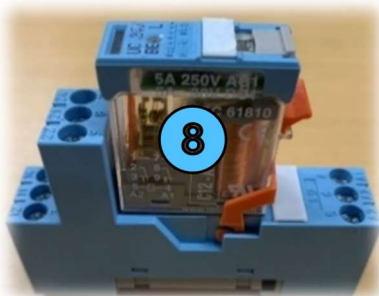

NOTE! If there was a **blue relay** installed;

The gap in the frame needs to be enlarged with metal scissors to prevent the new circuit board from touching the frame. If the 230VAC circuit is too close touching the frame, a short circuit may occur (1).

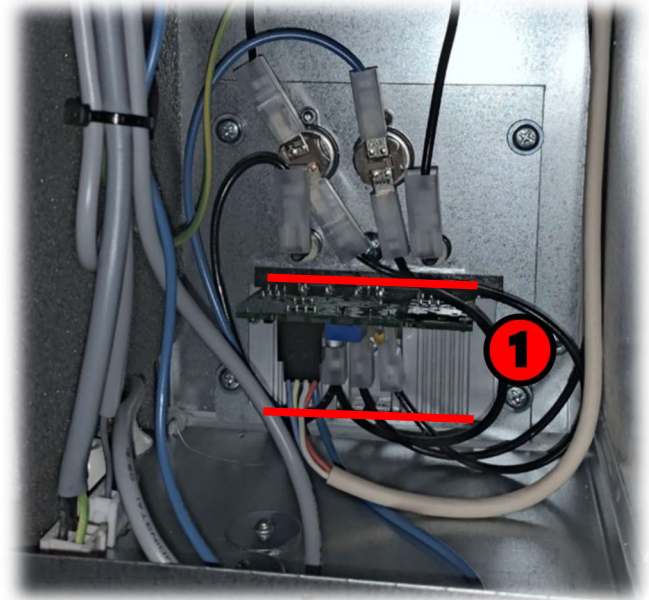

NOTE! If there was no **blue relay** installed in the electrical box;

Remove **the old triac control cable (2)** and install **the new triac control cable (3)** (40030313).

Connect the triac board according to the electrical diagram (**page 31**).
To lengthen the original wires; use the delivered cables and connection terminals (40028780, 40028781, 40029982).

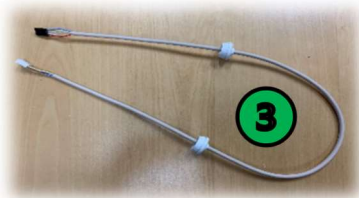

Remove **the fan cables (1)**.

Remove **the extract air sensor cable (2)**.

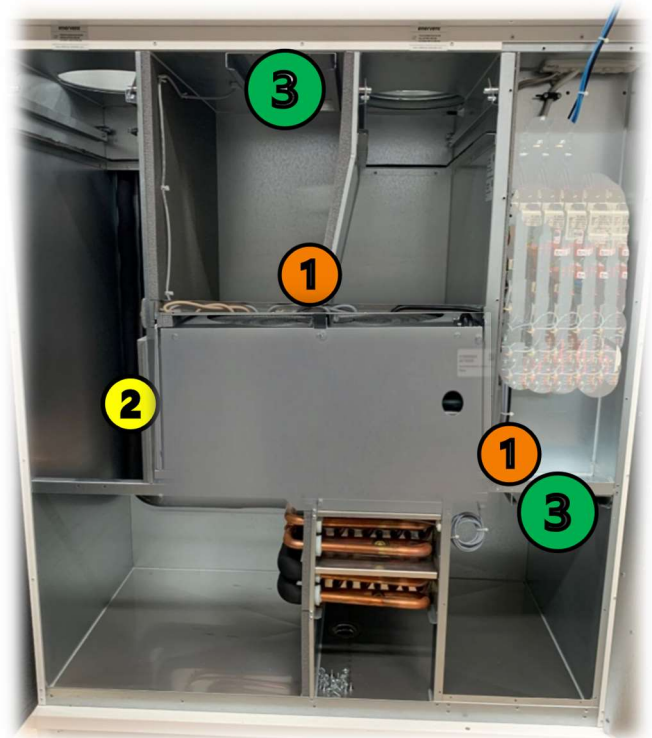

Remove the POP rivets from **the fan rails (3)** by drilling, and remove the rails (they are also glued to the frame).

Install **the new extract air sensor (4)** (40029225) and attach it with **cable ties** (40030997) on top of the old sensor. The old sensor won't be used anymore.



Cut a gap in the insulation and install the extract air sensor cable into **the gap (4)** and through the cable rail into the electrical box.



Install **the new fan rails (1)** (10026631).

by:

- drilling new 3,2mm holes for **the new POP-rivets** (40031559).
- placing sealant between the frame and the fan rails.
ex. Wurth silicone sealant.
- attaching the new fan rails to the frame with **the new POP-rivets** (40031559).

Drill two 18mm holes in the frame (where the old fan cables were attached *(if needed)*), install **new cable sealings** (40030101) and install **the new fan cables (2)** (40028782, 40028783, 40028784, 40028785).

Install the cables in **the electrical box (3)**.

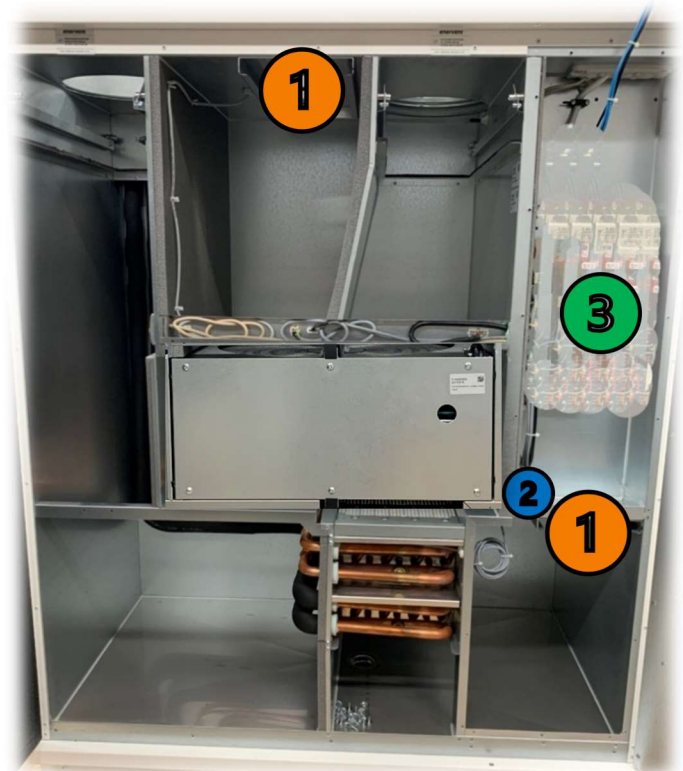

If the unit has a DC HRW installed, jump to page 14.

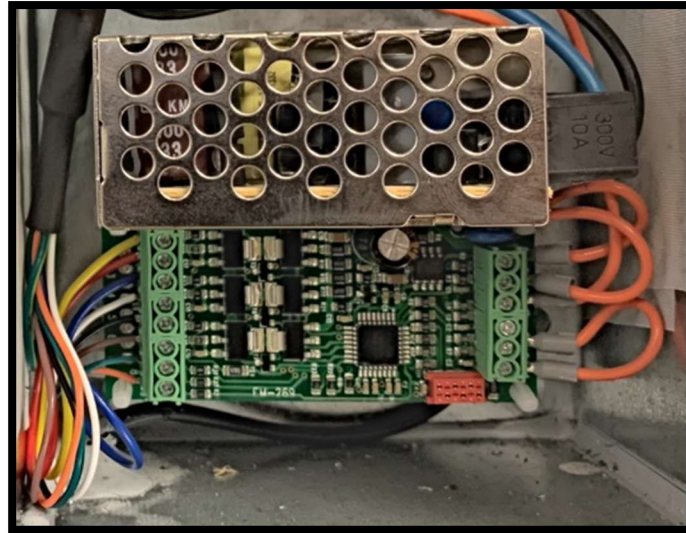

If the unit has an AC HRW installed, follow the instructions on the next page.

If the AC HRW control board is installed separately in the electrical box, there is no need to move it physically (if the new automation base fits). Just connect it like advised (page 14, 20).

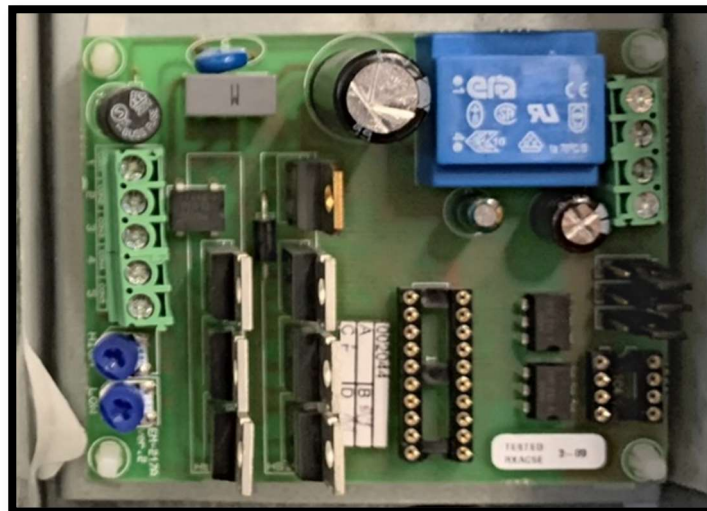

Remove **the PCB supports (1)** from the new automation base.

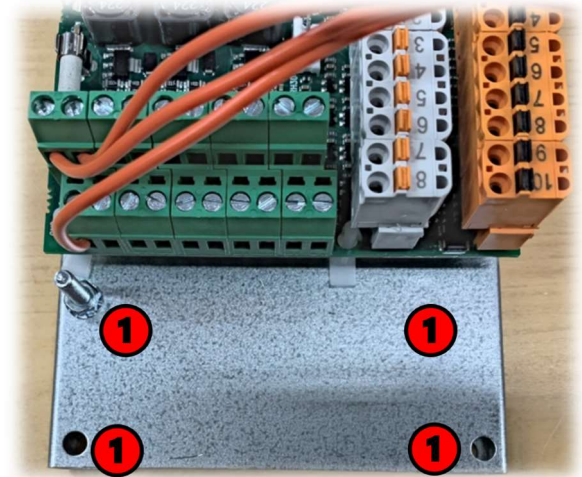

Mark **the holes (1)** to the automation base.

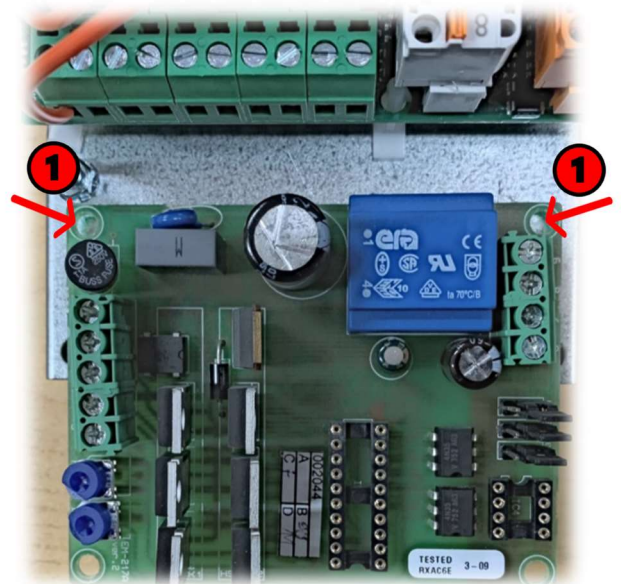

Cut **two of the new PCB supports (2)** (40030936).

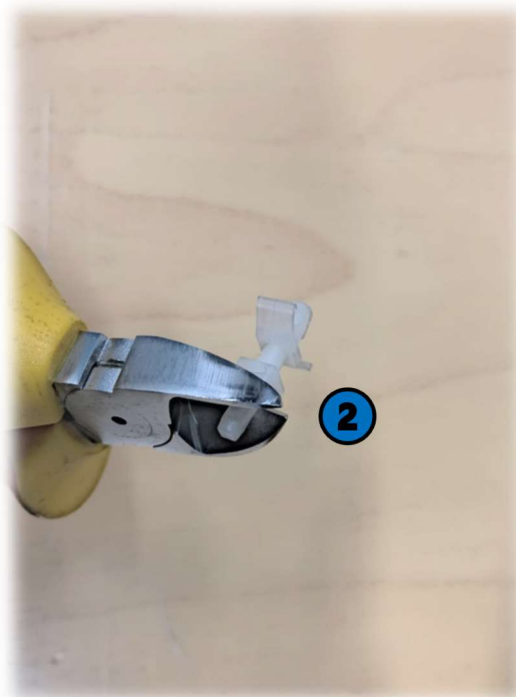

Drill **four 4,5mm holes (1)** according to the previous markings as shown in the picture.

Install **the new PCB supports (1)** (40030936).

Attach the AC HRW circuit board to the PCB supports.

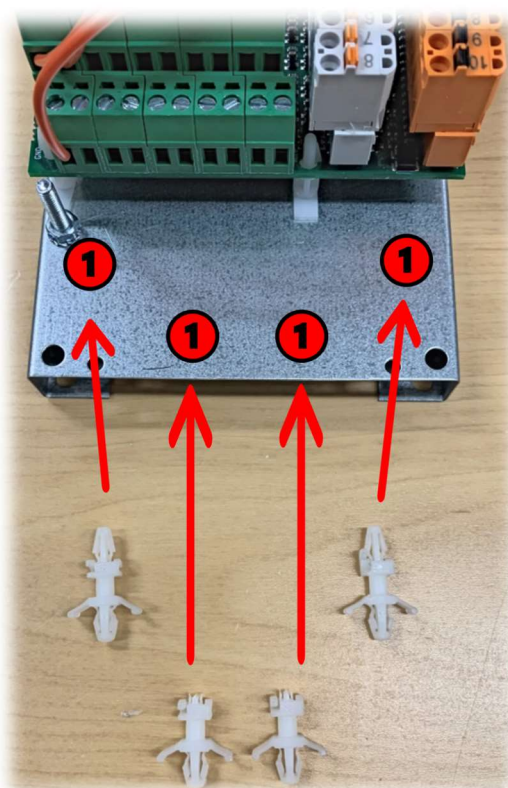

Disconnect and remove
the wires connected to "DO4" (1).

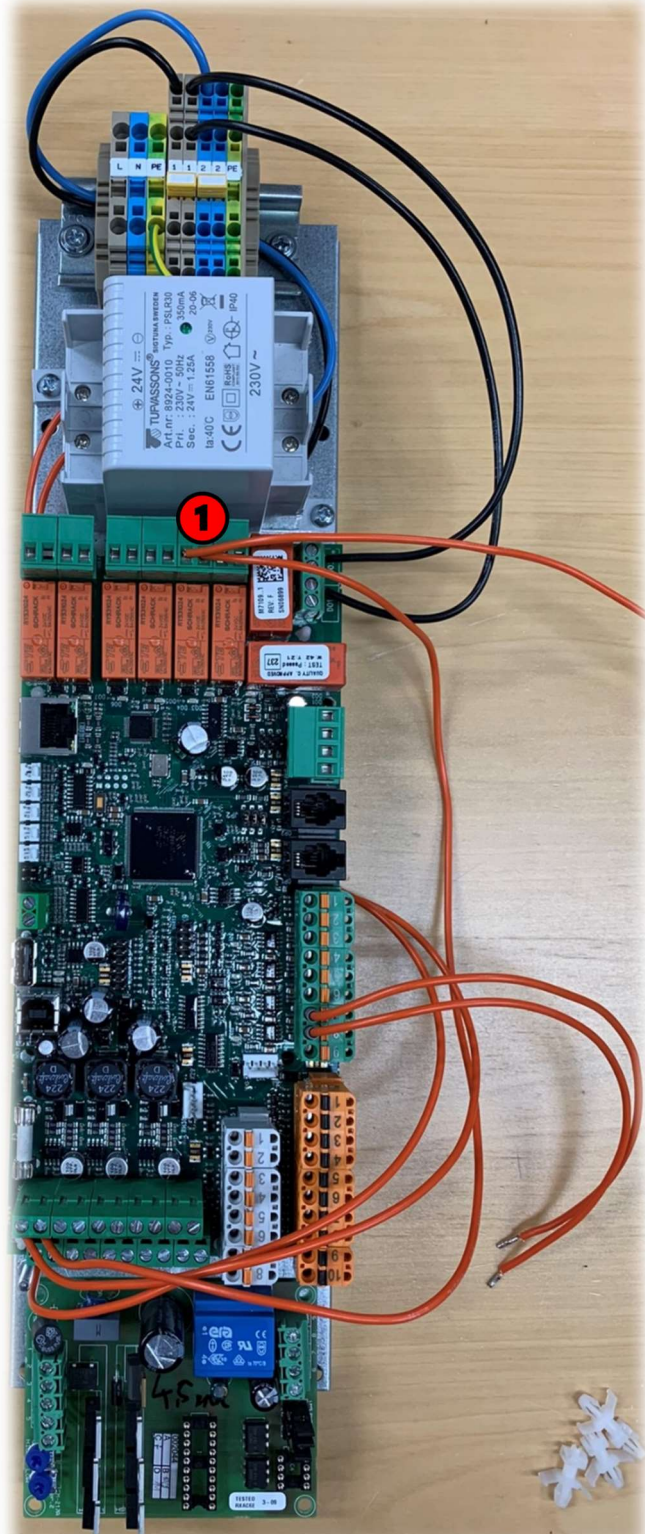

Connect **the black wire** (40028774) to connection terminal "1" and to "DO4" (1).

Connect **the black wire** (40028780) to "DO4" and to the AC HRW circuit board connector "1" (2).

Connect **the blue wire** (40028781) to connection terminal "2" and to the AC HRW circuit board connector "2" (3).

Connect **the wire from eAir main board connector "7"** to AC HRW circuit board "8".

Connect **the wire from eAir main board connector "8"** to AC HRW circuit board "7".

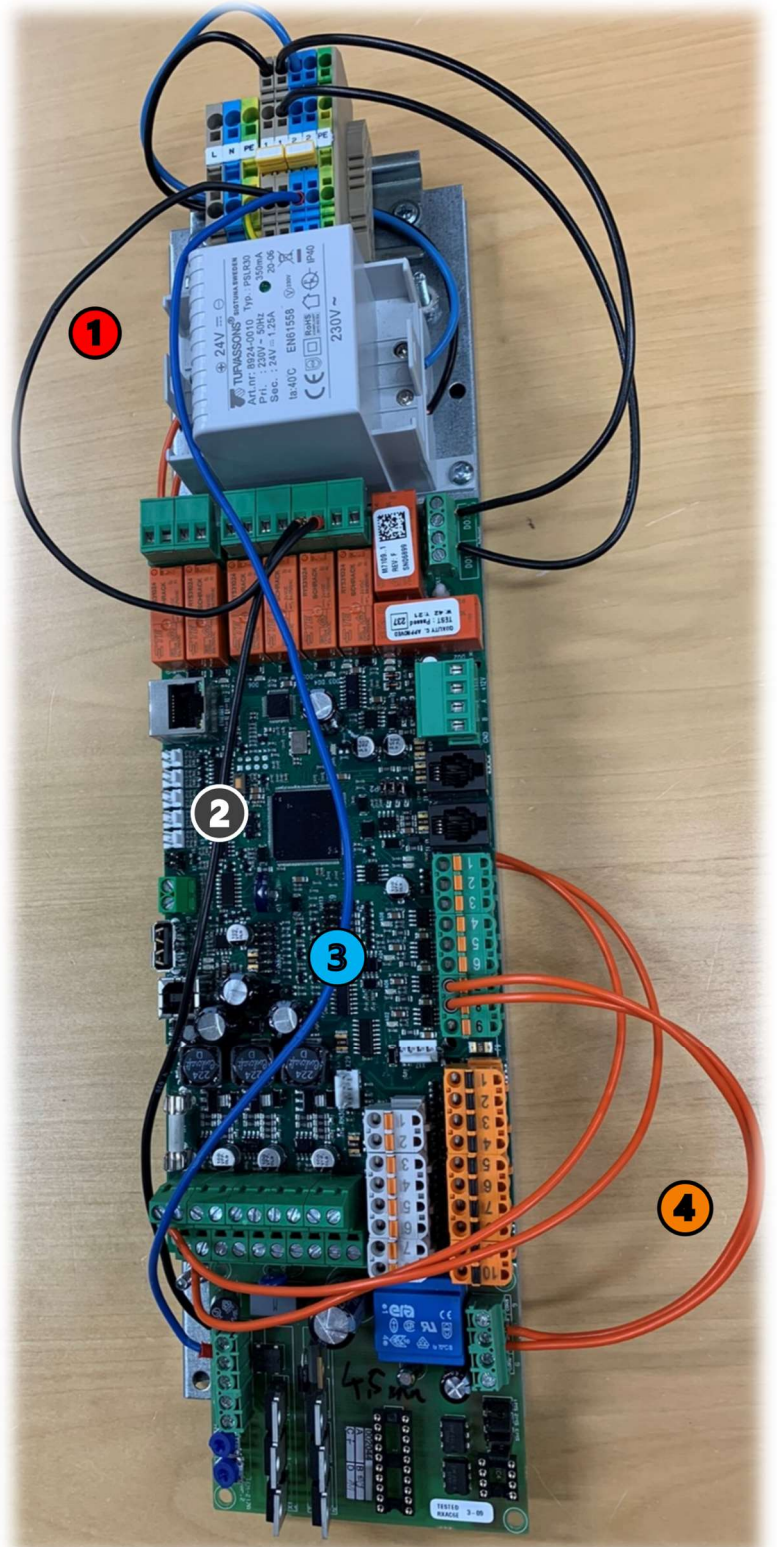

4

Install **the new automation (3)** in the electrical box. Make sure no installed cable / sensor get stuck behind the automation base and that they are available in front of the main board.

Attach **the automation base (40029647)** to the electrical box with **four self tapping screws (4) (40031530)**.

If the new automation base doesn't fit in the electrical box; remove the old DC HRW control board from the electrical box and attach it to the new automation base (page 19).



Connect **the power cable to the terminals (1)**.

L: Brown

PE: Green/yellow

N: Blue

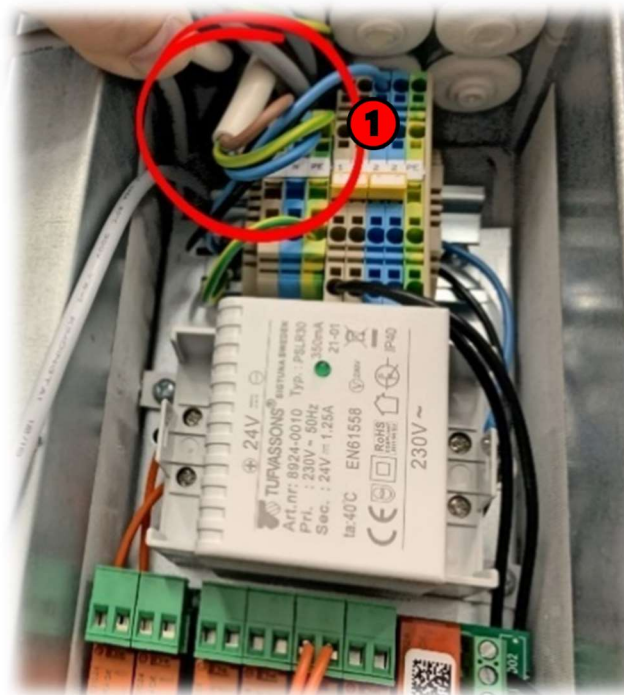

Connect **the ground wires** to **the automation base ground point (1)**.
 Supply air fan, extract air fan, (HRW), ground terminal.
 Tighten with **the nut (40031489)**.

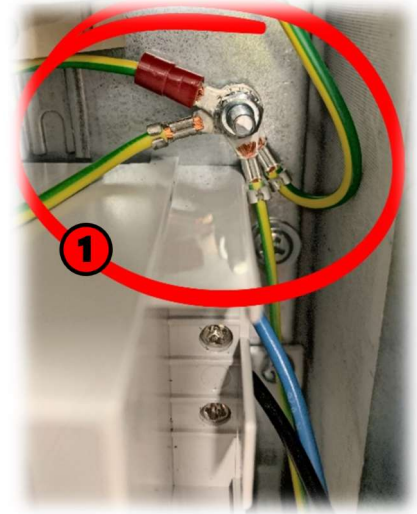

Connect **the blue wire** from the electrical after heater to **the blue "2" connection terminal (2)**.
 Ignore if no electrical after heater installed.

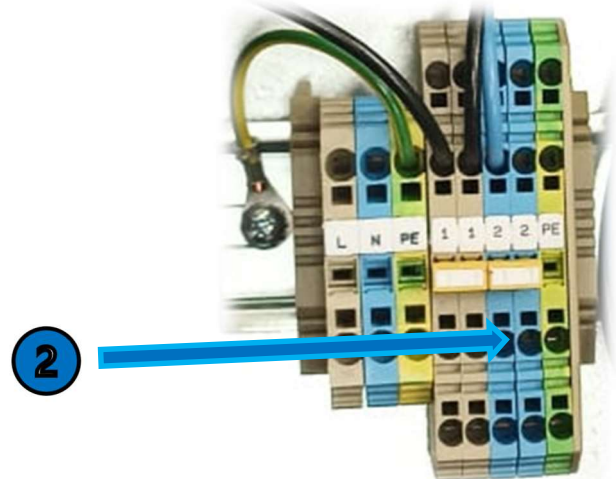

Connect **the brown wire** from the after heater to **"DO2" (2)**.
 If there is a water coil after heater installed, the circulation pump power wire (L) would be connected here.

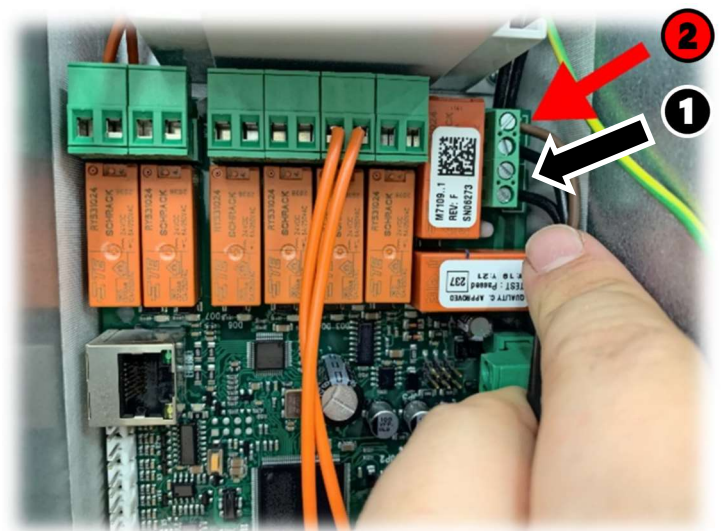

Connect **the wires marked "1"** in the fan power cables to **"DO1" (1)**.

Connect **the wires marked "2"** in the fan power cables to the **blue "2" connection terminal (2)**.

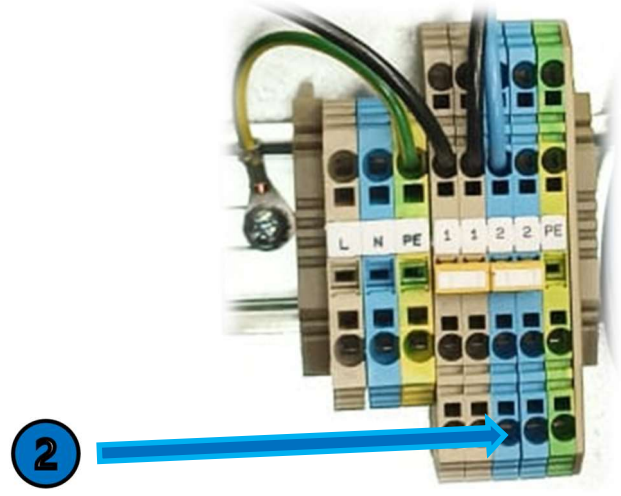

Connect **the extract air sensor (1)** (40029225) to the main board (X29).

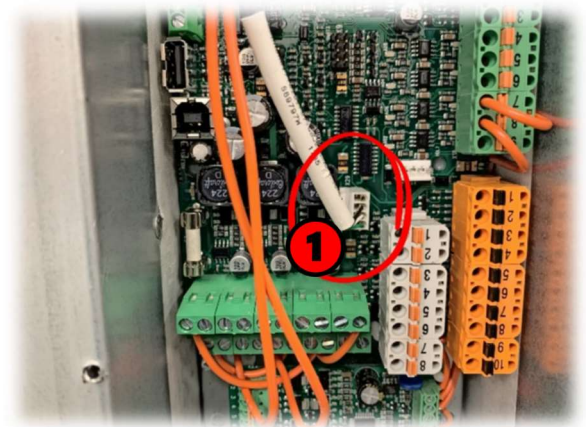

Connect **the sensors (1)** to the main board according to the markings.

- X1, TE01: Outside air
- X2, TE05: HRW supply air
- X3, TE10: Supply air
- X4, TE32: Waste air
- X12, TE45: Return water sensor (2)
if the unit has a water coil after heater installed.

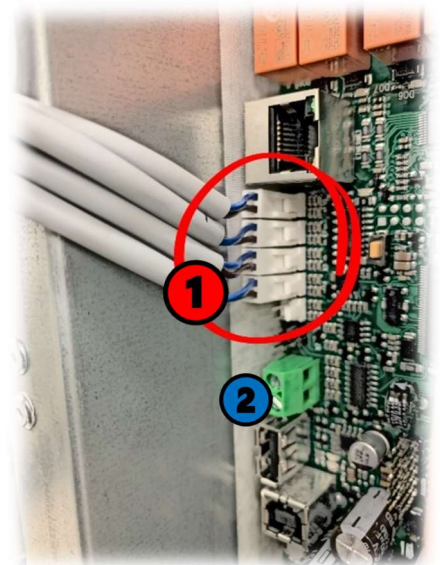

Connect **the wires from the supply air fan control cable (1)** (40028784) to the main board.

- 1: *Brown*
- 2: *Black*
- 3: *Gray*

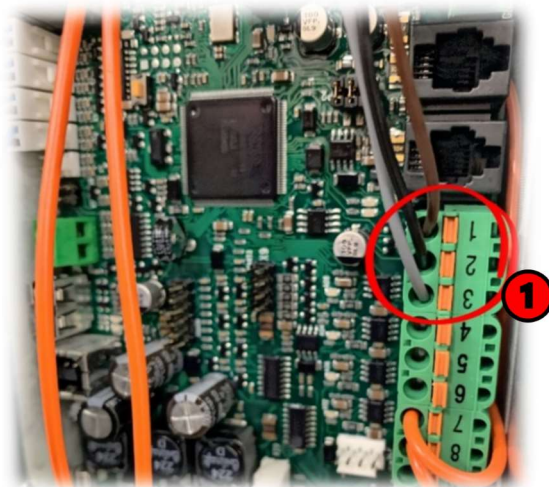

Connect **the wires from the extract air fan control cable (2)** (40028785) to the main board.

- 4: *Brown*
- 5: *Black*
- 6: *Gray*



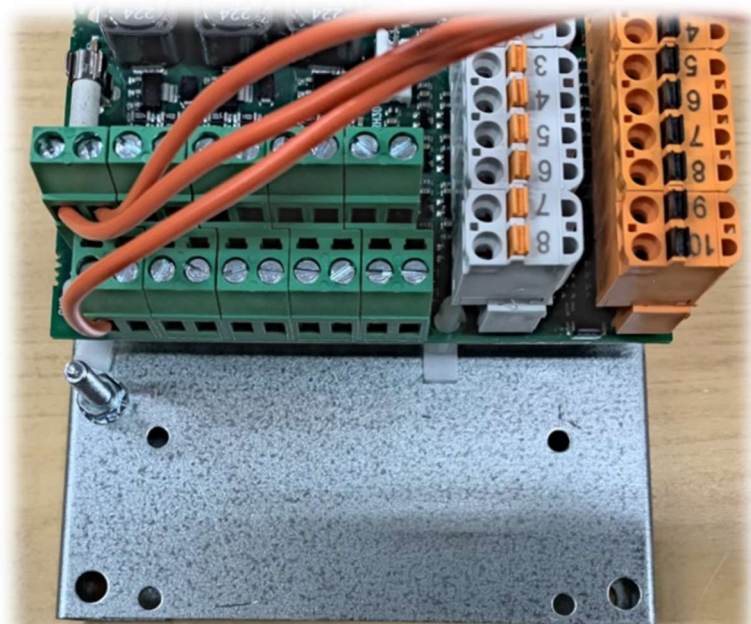

If DC HRW:

Install **the old DC HRW circuit board (1)** to the new automation base / or leave it in place if installed separately in the electrical box, and connect it to the main board (**page 20 & 30**).

The old transformer won't be used anymore!

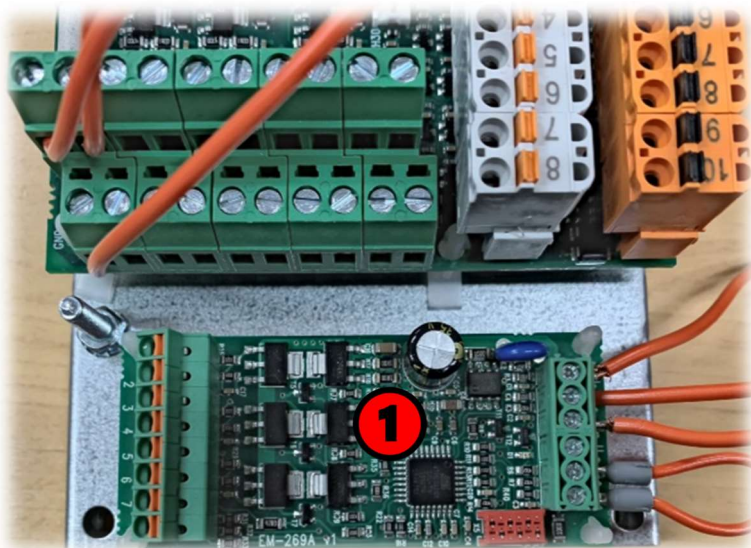

If DC HRW:

Connect **the wires from the HRW cable to the HRW control board (1).**

- 1: Yellow
- 2: Red
- 3: Blue
- 4: White
- 5: Black
- 6: Brown
- 7: Green
- 8: Orange

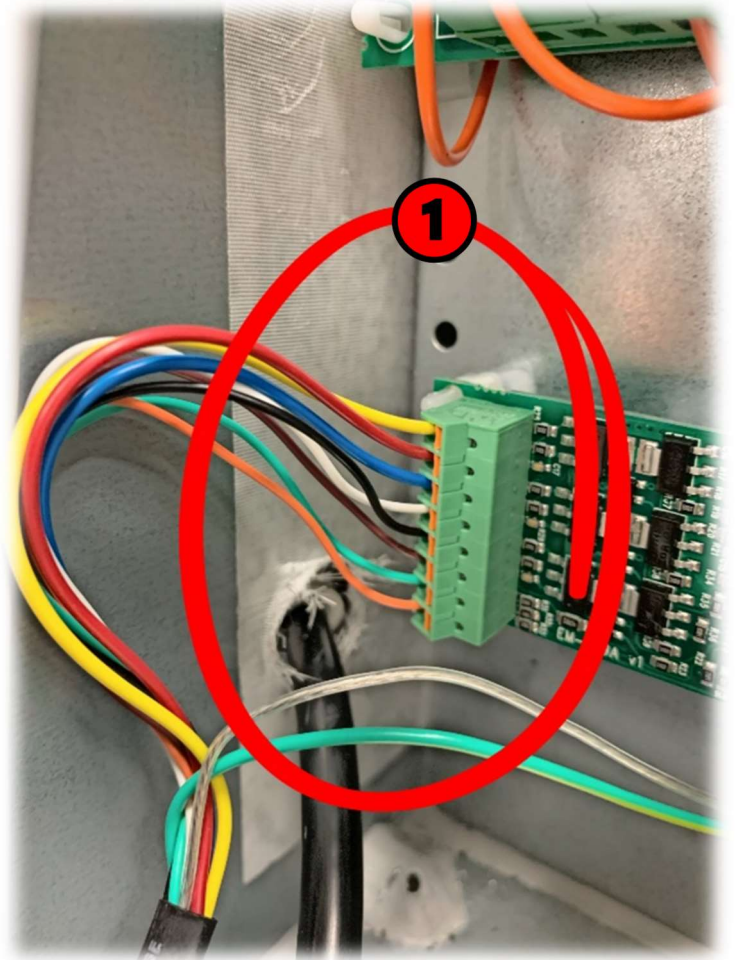

If AC HRW:

Connect **the wires from the HRW cable to the HRW control board (2).**

- 3: Brown / (1)
- 4: Gray / (2)
- 5: Black / (3)



If DC HRW:

Release **the screw (1)** from the automation base and attach **the ground wire** from the HRW cable to the screw, along with **a washer** (40031537).

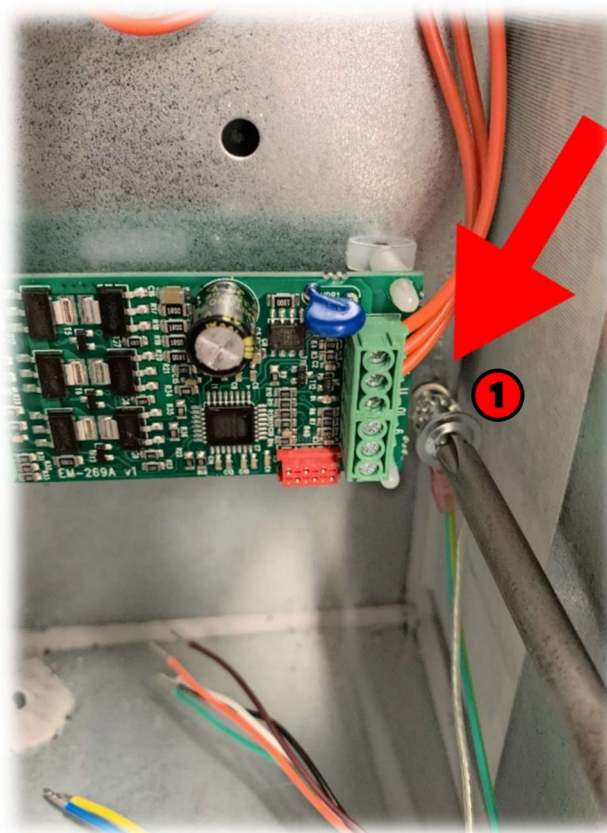
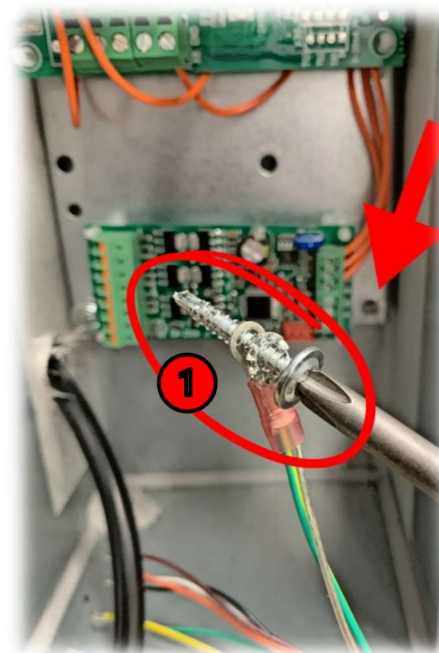

Reattach **the screw (1)** to the automation base.

Connect **the after heater control cable (1)** to the main board (X17).
Ignore if the unit has a water coil after heater installed.

Connect other components (for example actuator for cooling coil or water coil after heater) according to the electrical diagrams (pages 29-32).

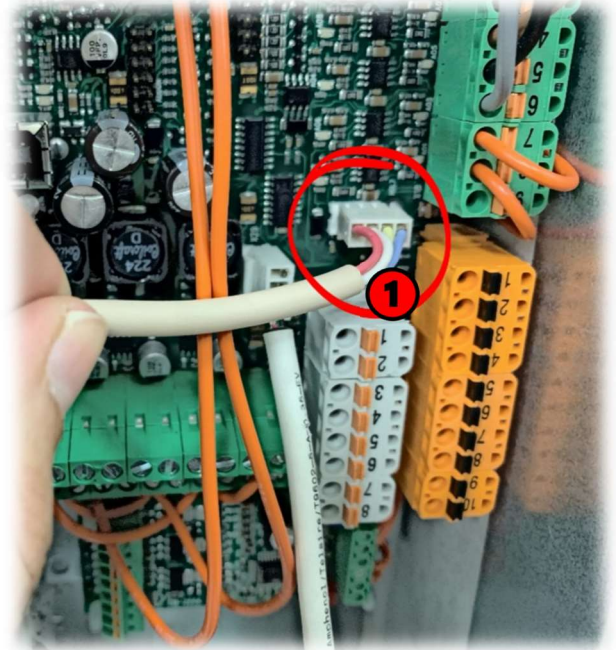

Connect **the main switch wires** to the main switch and to **the connection terminals**.

L: Black (3)
 N: Blue (4)

1: Black (1)
 2: Blue (2)

Attach all cables and wires together with **cable ties** (40030997).

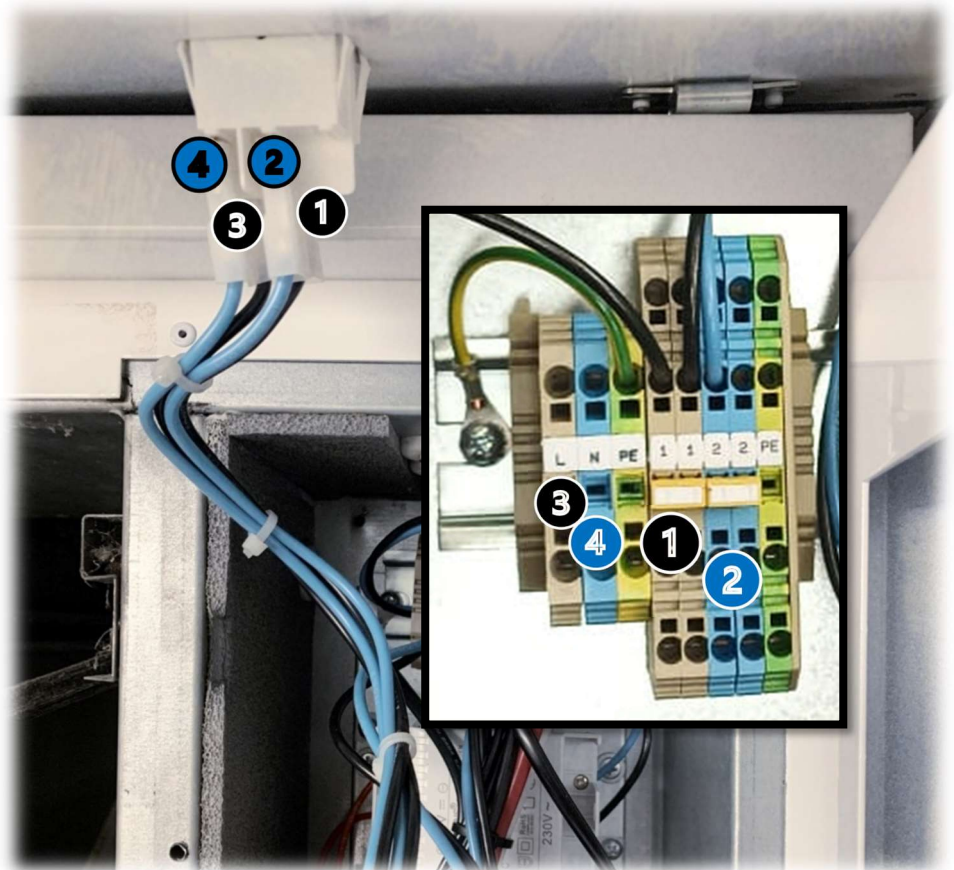

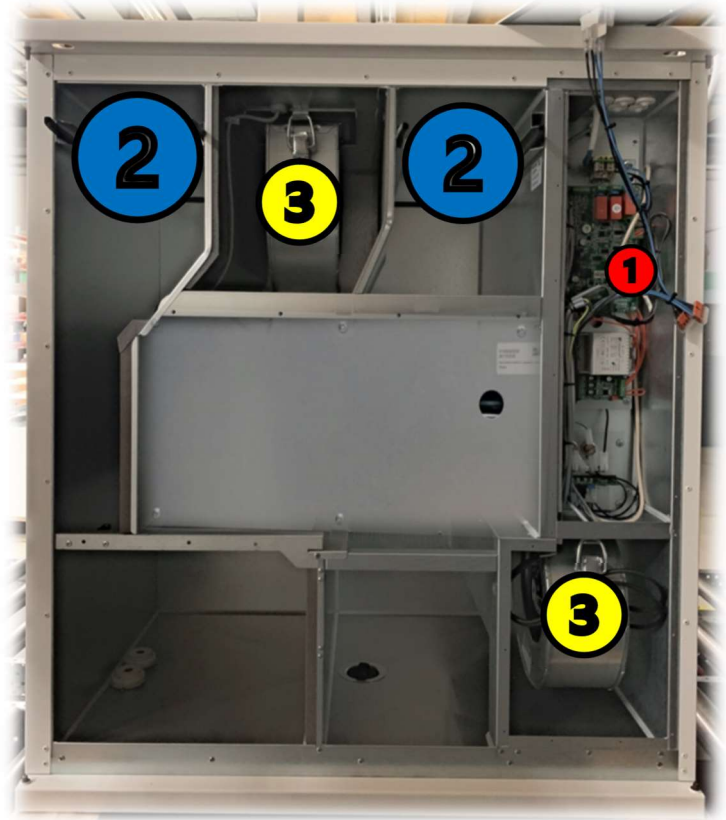

Connect **the display cable (1)** to the main board.

Install **the filters (2)**.

Install **the new fans (3)** (10023316, 10023315).

Disconnect and remove the old display.
Install **the new display (4)** (40031114) in a desired place.



Install **the WiFi module (5)** (40034288).



Attach the cover to **the electrical box (1)** and **the supply air fan chamber (1)**.

Attach **the cover to the cable rail (2)** with **the new POP rivets (40031559)**.

Install **the new type plate sticker (3)**.

Close the service door.

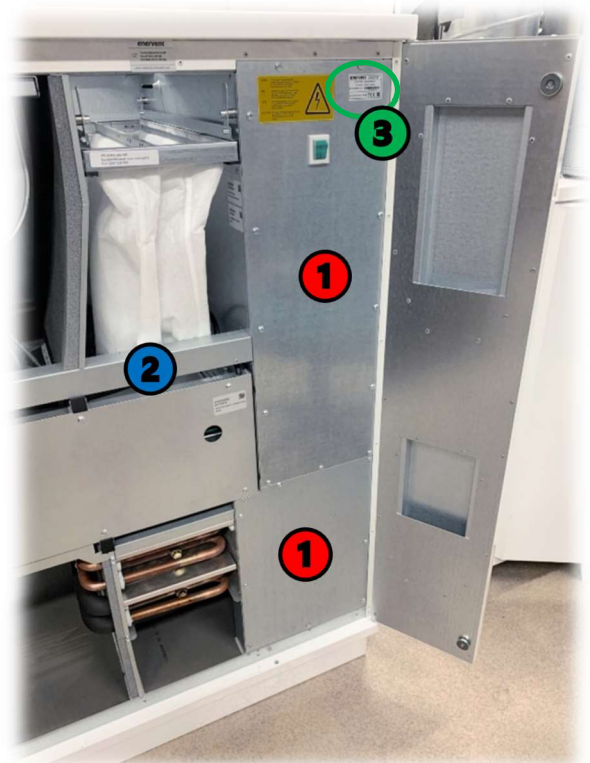

Turn on **the main switch (4)** and perform insulation and ground continuity test according to regulations.



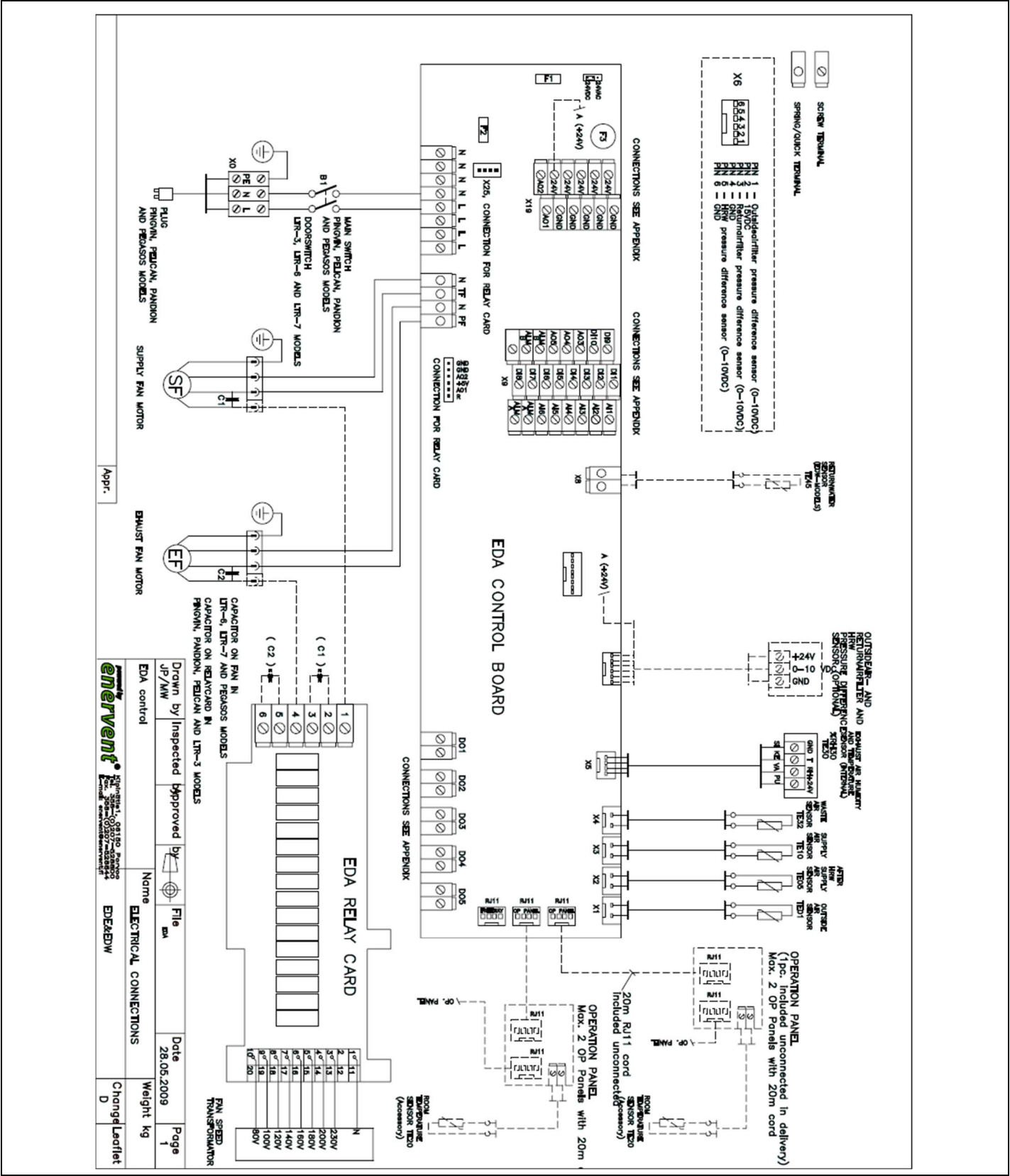

enervent
 Porvoo, Finland

Drawn by: JP/MM
 Inspected by: Appr.
 Approved by: EDEABDW
 Date: 28.05.2009
 Weight: kg
 Page: 1

File: EN
 Name: ELECTRICAL CONNECTIONS
 Change: D

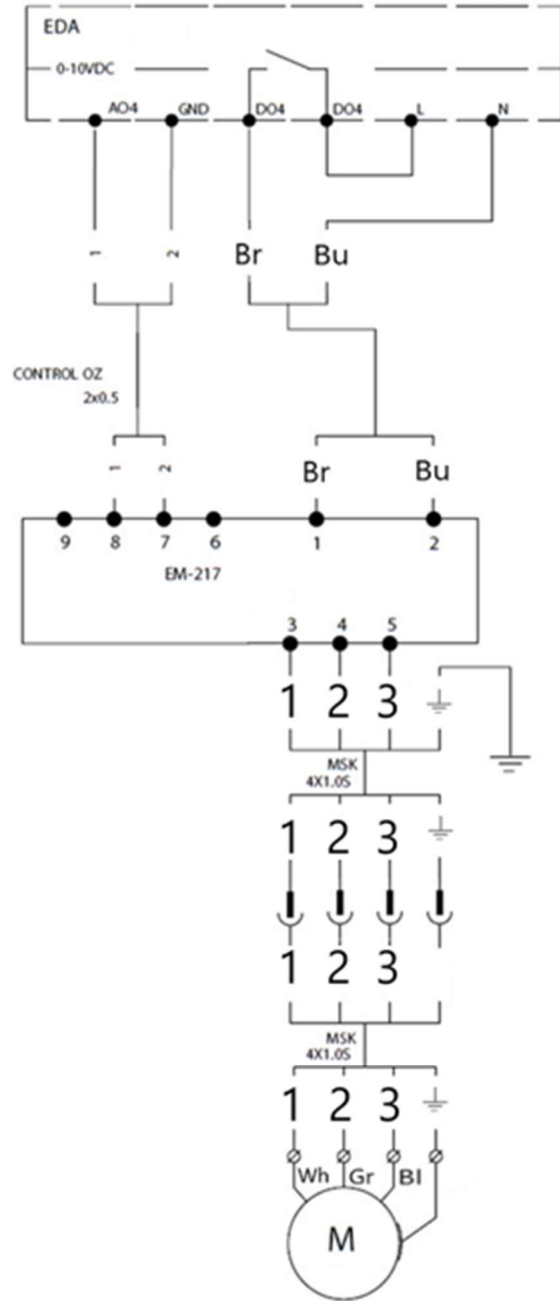

Bl: Black
 Bu: Blue
 Br: Brown
 Wh: White
 Gr: Gray

HRW MOTOR

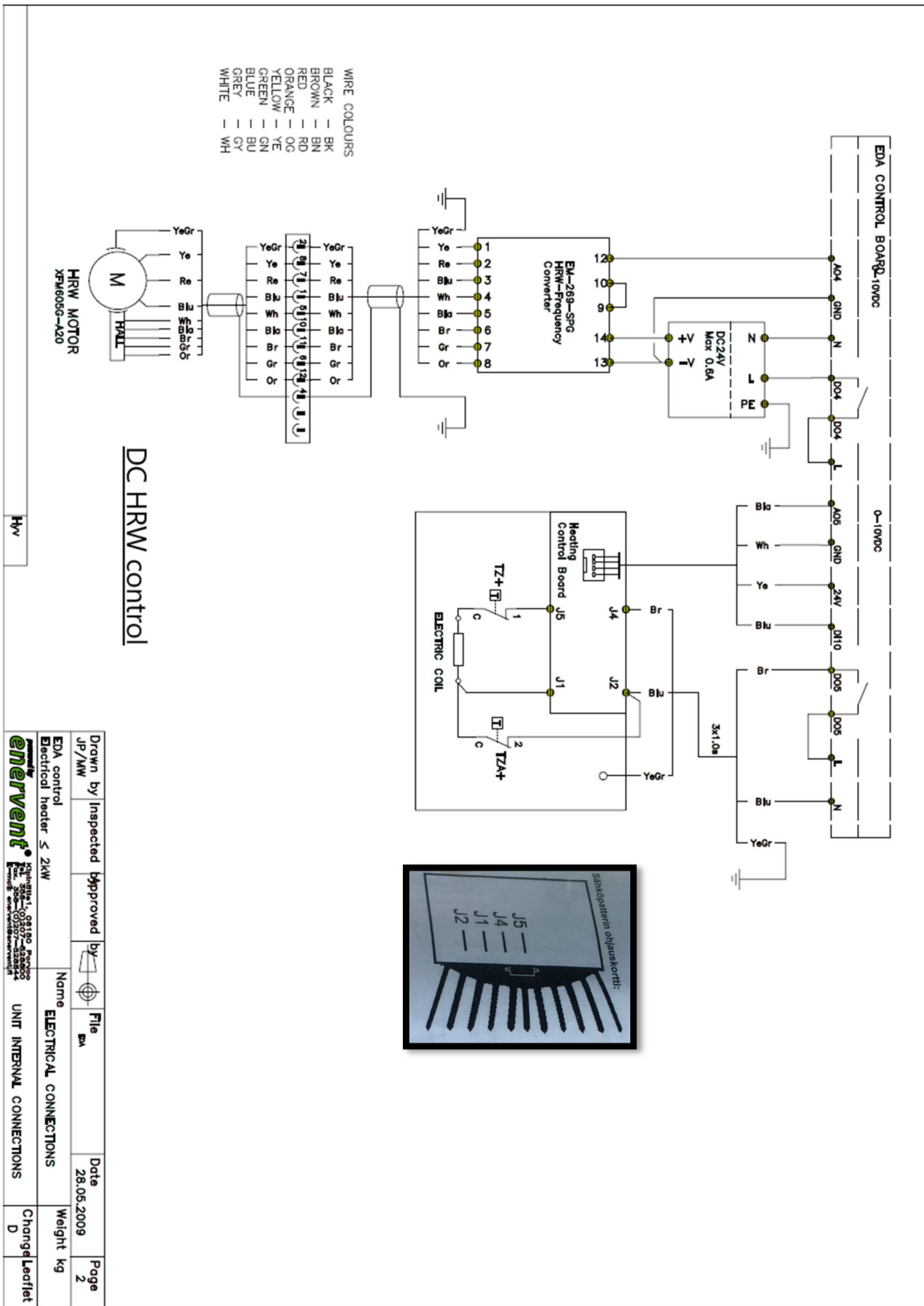

| | | | | | | |
|--|-----------|----------|---------------------------|------|------------|------|
| Drawn by | Inspected | Approved | by | File | Date | Page |
| JP/MW | | | | EDA | 28.05.2009 | 2 |
| EDA control | | | Name | | | |
| Electrical header ≤ 2kW | | | ELECTRICAL CONNECTIONS | | | |
| enervent | | | UNIT INTERNAL CONNECTIONS | | | |
| Energia- ja lämmitystekniikan tutkimuskeskus P.O. Box 101377 00131 Vammala | | | Change/Leaflet | | | |
| | | | D | | | |

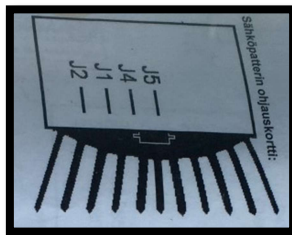

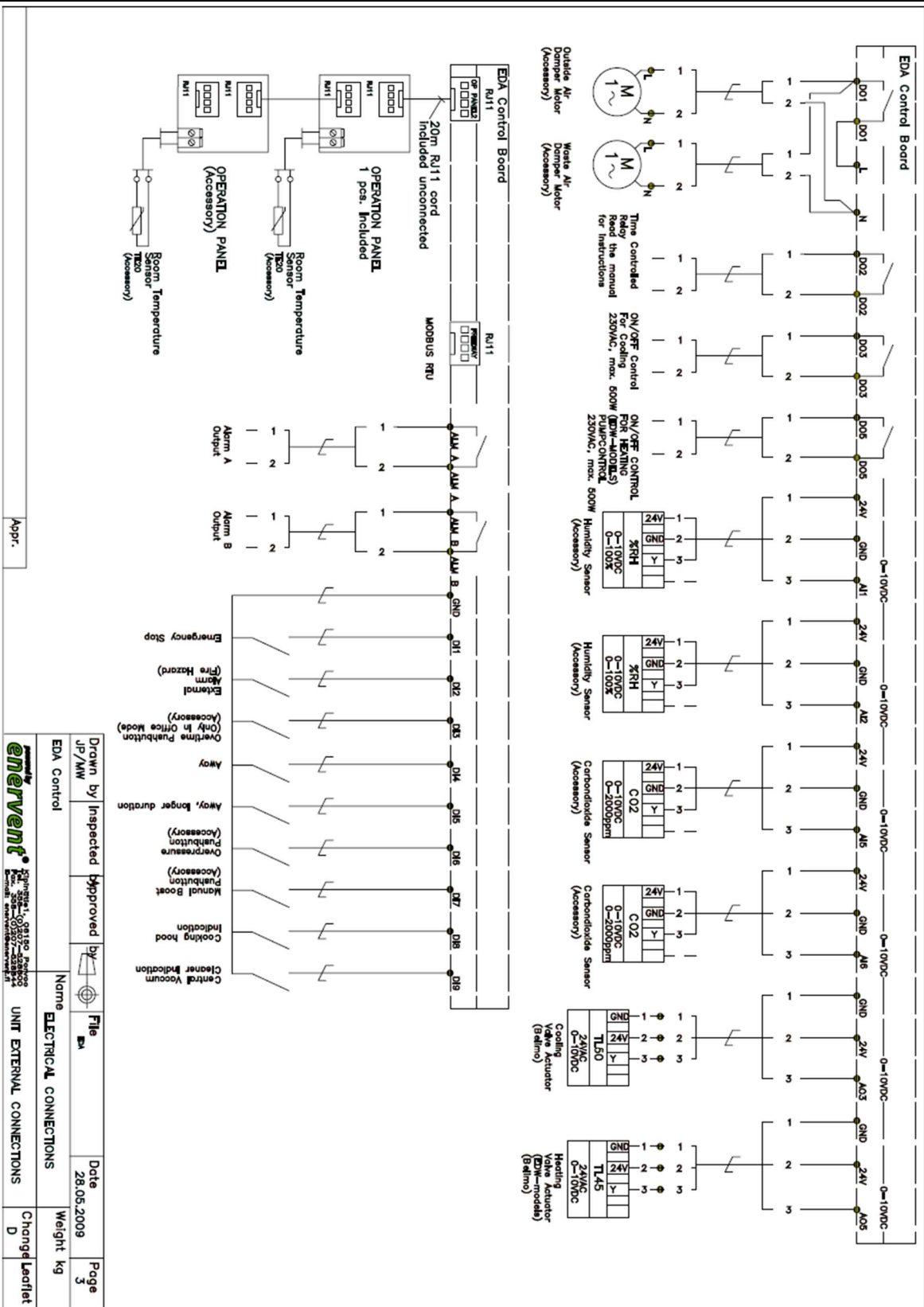

| | | | | | |
|--------------------------------|-----------|------------|----|--------------------|-----------|
| Drawn by JP/MW | Inspected | Approved | by | Date 28.05.2009 | Page 3 |
| Name EDA Control | | File EM | | Weight kg | |
| Name ELECTRICAL CONNECTIONS | | | | Change Leadlet | |
| UNIT EXTERNAL CONNECTIONS | | | | D | |

Appr.

enervent
Sähkötekniikka, Oyj:n
Suomen Sähkötekninen
Yhteisö Oy
Puhelin: 02055 22000
Faksi: 02055 22001
www.enervent.fi

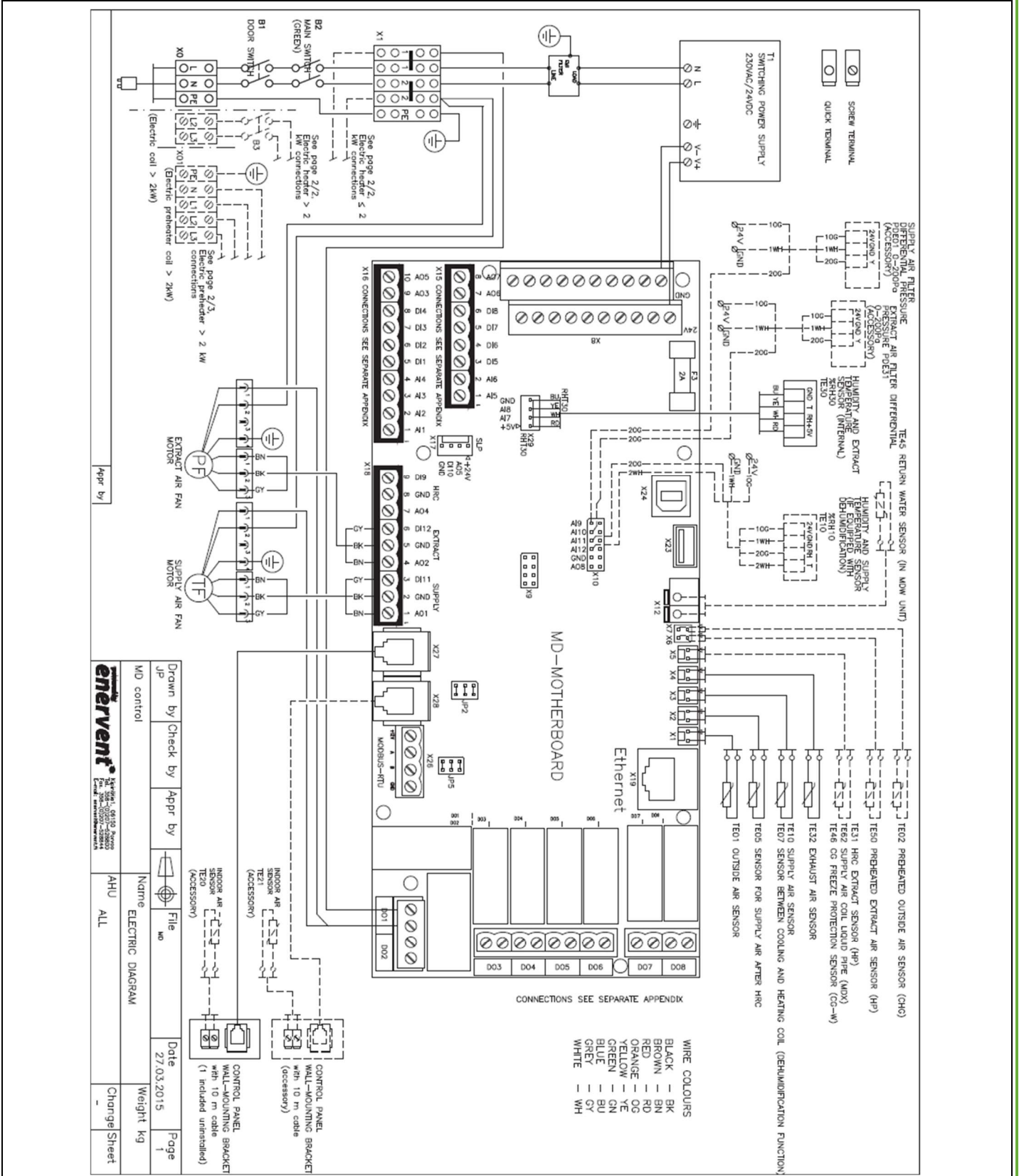

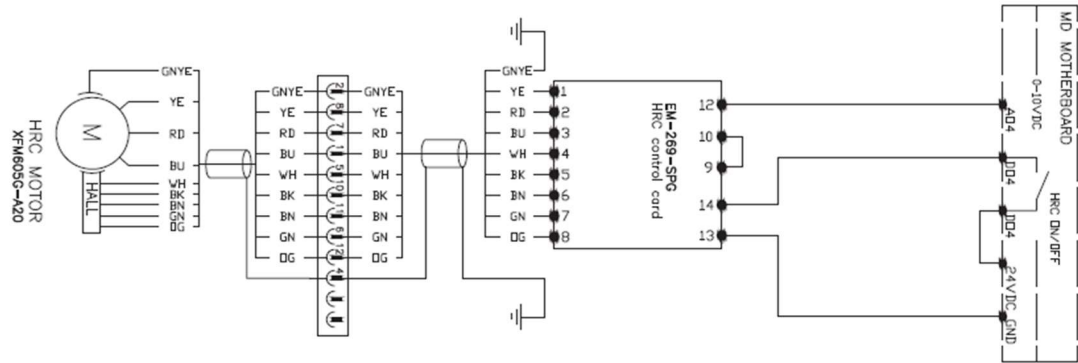

WIRE COLOURS
 BLACK — BK
 BROWN — BN
 RED — RD
 ORANGE — OG
 YELLOW — YE
 GREEN — GN
 BLUE — BU
 GREY — GY
 WHITE — WH

Appr by

| | | | | | |
|--|----------|---------|-----------------------------|--------------|------|
| Drawn by | Check by | Appr by | File | Appr by | Page |
| MK | | | mo | 30.08.2013 | 2 |
| MD Control HRC schematic | | | Name | Weight Kg | |
| Enarto, Enervent Oy Kipinätie 1, FIN-06150 Porvoo Tel. +358 207 528 800 enervent@enervento.com | | | AHU | Change Sheet | 1 |
| | | | ELECTRIC DIAGRAM | | |
| | | | UNIT'S INTERNAL CONNECTIONS | | |

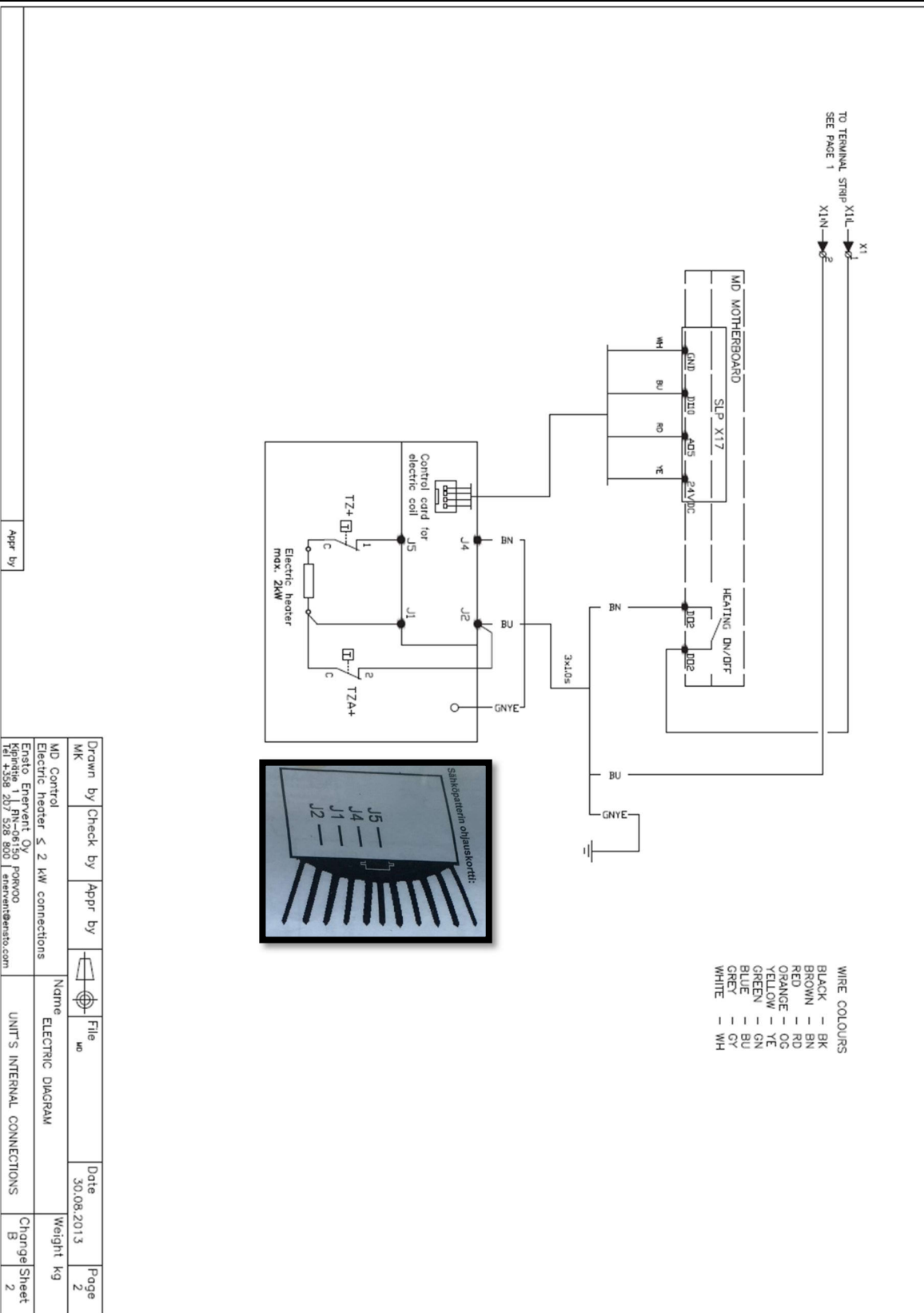

MANDATORY PARTS

| | | |
|----------|---|---|
| 10024054 | CONTROL UPDATE KIT PAN/PEL/PEG(XL) EDA → EAIR | 1 |
| 10023316 | FAN PACKAGE 170W SUPPLY AIR | 1 |
| 10023315 | FAN PACKAGE 170W EXTRACT AIR | 1 |
| 10026631 | FAN RAIL PACKAGE PANDION | 1 |

OPTIONAL PARTS

| | | |
|----------|-------------------------|---|
| 10023887 | ELECTRICAL HEATER 0,8kW | 1 |
|----------|-------------------------|---|

| <u>Code</u> | <u>Description</u> | <u>Pcs.</u> |
|-------------|---|-------------|
| 10024054 | CONTROL UPDATE KIT PAN/PEL/PEG(XL) EDA → EAIR | 1 |

Automation

| | | |
|----------|--------------------------------|---|
| 40030936 | PCB support KGLS-6S | 5 |
| 40030937 | PCB support LCBSM-6-01 | 4 |
| 40031695 | Screw DIN 7981 ZN 3,9x9,5 | 4 |
| 40031631 | Screw DIN 7985 ZN M4x20 | 1 |
| 40031537 | Washer 6798-A ZN M4x8 | 3 |
| 40031489 | Nut DIN 934/8 ZN M4 | 1 |
| 40028772 | Wire 65mm orange 0,75mm2 | 1 |
| 40028773 | Wire 340mm orange 0,75mm2 | 6 |
| 40028774 | Wire 255mm 1mm2 black | 3 |
| 40028779 | Wire 255mm 1mm2 blue | 1 |
| 40031093 | eAir main board | 1 |
| 40029985 | eAir main board connectors | 1 |
| 40029195 | Power supply Tufvassons PSLR24 | 1 |
| 40028788 | Ground wire 100mm | 1 |
| 40029647 | Automation base | 1 |
| 40029344 | Terminal package | 1 |

Components

| | | |
|----------|---|----|
| 40030936 | PCB support KGLS-6S | 4 |
| 40030100 | Cable sealing VET 5-7 | 6 |
| 40030101 | Cable sealing VET 7-10 | 6 |
| 40028782 | Fan power cable supply air | 1 |
| 40028783 | Fan power cable extract air | 1 |
| 40028784 | Fan control cable supply air | 1 |
| 40028785 | Fan control cable extract air | 1 |
| 40029225 | Humidity/temperature sensor Amphenol 1800mm | 1 |
| 40031530 | Screw ZN 4,2x25 | 4 |
| 40028774 | Wire 255mm 1mm2 black | 3 |
| 40028781 | Wire 600mm 1mm2 blue | 1 |
| 40028780 | Wire 600mm 1mm2 black | 2 |
| 40029982 | WaGo 221-415 | 2 |
| 40031537 | Washer 6798-A ZN M4x8 | 1 |
| 40031489 | Nut DIN 934/8 ZN M4 | 1 |
| 40030997 | Cable tie 2,5x200mm | 10 |
| 40031559 | POP-rivet Multigrip 3,2x9 | 12 |
| 40031114 | eAir panel package | 1 |
| 40030313 | Triac cable 1000mm 4-pole | 1 |
| 40034288 | WiFi module package | 1 |

Manuals etc. (depends on model)

| | |
|--------------------------|---|
| eAir installation manual | 1 |
| eAir user manual | 1 |
| eAir electrical diagrams | 1 |

MANDATORY PARTS

| | | |
|----------|---|---|
| 10024054 | CONTROL UPDATE KIT PAN/PEL/PEG(XL) EDA → EAIR | 1 |
| 10023316 | FAN PACKAGE 170W SUPPLY AIR | 1 |
| 10023315 | FAN PACKAGE 170W EXTRACT AIR | 1 |
| 10026631 | FAN RAIL PACKAGE PANDION | 1 |

| <u>Code</u> | <u>Description</u> | <u>Pcs.</u> |
|-------------|---|-------------|
| 10024054 | CONTROL UPDATE KIT PAN/PEL/PEG(XL) EDA → EAIR | |

Automation

| | | |
|----------|--------------------------------|---|
| 40030936 | PCB support KGLS-6S | 5 |
| 40030937 | PCB support LCBSM-6-01 | 4 |
| 40031695 | Screw DIN 7981 ZN 3,9x9,5 | 4 |
| 40031631 | Screw DIN 7985 ZN M4x20 | 1 |
| 40031537 | Washer 6798-A ZN M4x8 | 3 |
| 40031489 | Nut DIN 934/8 ZN M4 | 1 |
| 40028772 | Wire 65mm orange 0,75mm2 | 1 |
| 40028773 | Wire 340mm orange 0,75mm2 | 6 |
| 40028774 | Wire 255mm 1mm2 black | 3 |
| 40028779 | Wire 255mm 1mm2 blue | 1 |
| 40031093 | eAir main board | 1 |
| 40029985 | eAir main board connectors | 1 |
| 40029195 | Power supply Tufvassons PSLR24 | 1 |
| 40028788 | Ground wire 100mm | 1 |
| 40029647 | Automation base | 1 |
| 40029344 | Terminal package | 1 |

Components

| | | |
|----------|---|----|
| 40030936 | PCB support KGLS-6S | 4 |
| 40030100 | Cable sealing VET 5-7 | 6 |
| 40030101 | Cable sealing VET 7-10 | 6 |
| 40028782 | Fan power cable supply air | 1 |
| 40028783 | Fan power cable extract air | 1 |
| 40028784 | Fan control cable supply air | 1 |
| 40028785 | Fan control cable extract air | 1 |
| 40029225 | Humidity/temperature sensor Amphenol 1800mm | 1 |
| 40031530 | Screw ZN 4,2x25 | 4 |
| 40031537 | Washer 6798-A ZN M4x8 | 1 |
| 40028774 | Wire 255mm 1mm2 black | 3 |
| 40028781 | Wire 600mm 1mm2 blue | 1 |
| 40028780 | Wire 600mm 1mm2 black | 1 |
| 40031489 | Nut DIN 934/8 ZN M4 | 1 |
| 40030997 | Cable tie 2,5x200mm | 10 |
| 40031559 | POP-rivet Multigrip 3,2x9 | 12 |
| 40031114 | eAir panel package | 1 |
| 40030313 | Triac cable 1000mm 4-pole | 1 |
| 40034288 | WiFi module package | 1 |

Manuals etc. (depends on model)

| | |
|--------------------------|---|
| eAir installation manual | 1 |
| eAir user manual | 1 |
| eAir electrical diagrams | 1 |

Notes: