

Automation upgrade

Pingvin MCC -> eAir

NOTE!

This upgrade can't be applied to a Pingvin unit with screwable service door locks (older than 2002).

NOTE!

F7 filters after heat recovery in the supply air chamber can't be used anymore after upgrade.

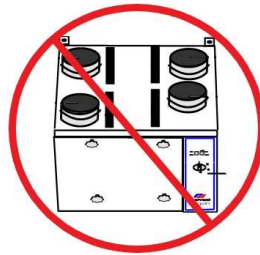

Warning!

According to regulations, an ordinary electricity consumer is only allowed to perform some minor service tasks.

A list of the allowed tasks can be found at the Tukes home page (Finland) (www.tukes.fi).

Always make sure that the power supply is turned off before opening the service door.

Wait two minutes before beginning the maintenance work. The fans rotate for some time by themselves, and the heating element may be hot even if the power supply of the ventilation unit is switched off. Electrical housing may be opened only by a trained electrician.

Electrical installations must comply with local regulations.

**Continuously check and compare the electrical diagrams at the end
of this instruction as the upgrade progresses!**

Table of contents

Upgrade..... 3
Electrical diagrams MCC 33
Electrical diagrams eAir 34
Parts list eAir E..... 38
Notes 39

Open **the small door (1)** by pressing on it.



Disconnect **the power cord (1)** (and other power supplies if available).



Open the service door by turning **the two locks (1)** counterclockwise. If there is a remote panel installed in the small door, cut the cord and remove the remote panel or leave it in place. Either way, the panel can't be used anymore.



Remove **the doors (1)** by lifting and pulling. The doors will detach from **the pins (2)**.

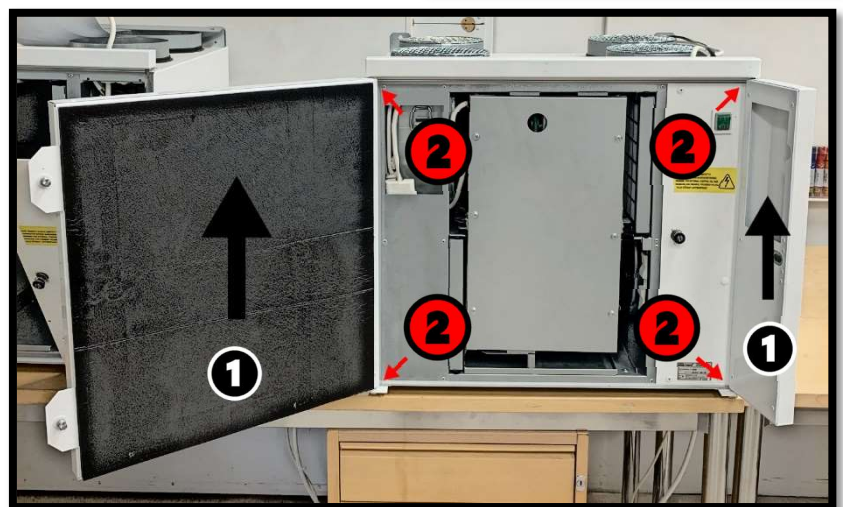

Remove **the filters (1)** by pulling.



Disconnect **the power cord (1)** from the heat exchanger.

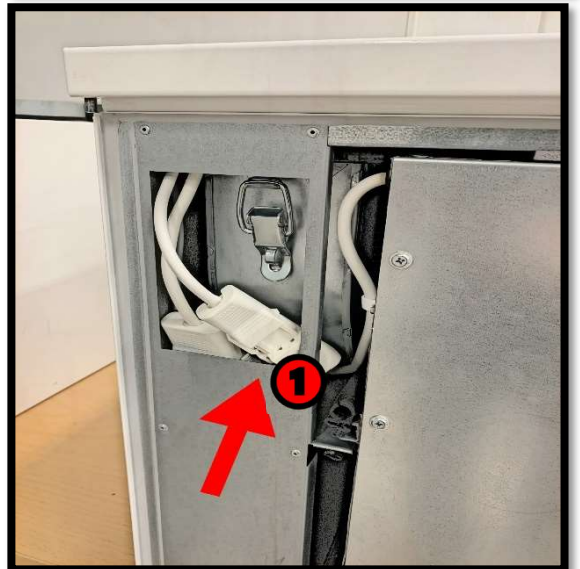

Remove **the heat exchanger (1)** by pulling.



Disconnect **the power cord (1)**, release **the pin (2)** and remove the extract air fan.

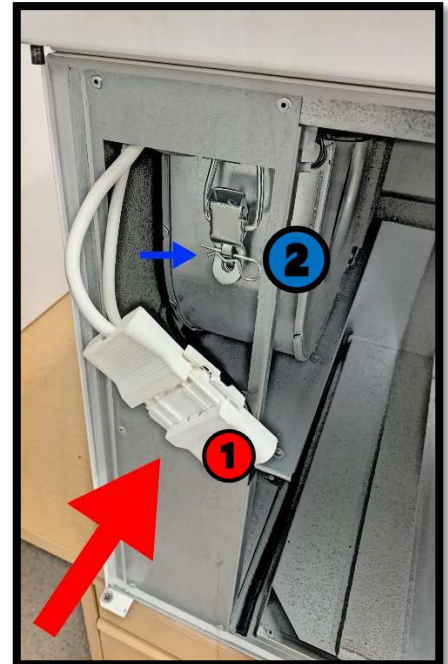

Remove **the screw (1)** from the filter rail.



Disconnect **the power cord (1)**, release **the pin (2)** and remove the supply air fan.

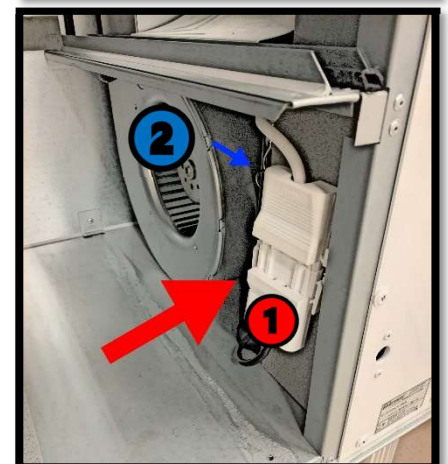

Open the electrical box by removing **the screws (1)**.



NOTE! Ensure that no voltage is occurring in the electrical box before proceeding!

Disconnect **all wires from the main switch and the ground wire (1)** from the cover.



Disconnect **the power supply wires (1)**.

Disconnect and remove **the main switch wires (2)**.

Disconnect **all ground wires (3)** from the automation base ground point.

Disconnect **the rest of the wires (4)**.

Remove **the screws (5)**, and remove the automation base including capacitors and transformer.

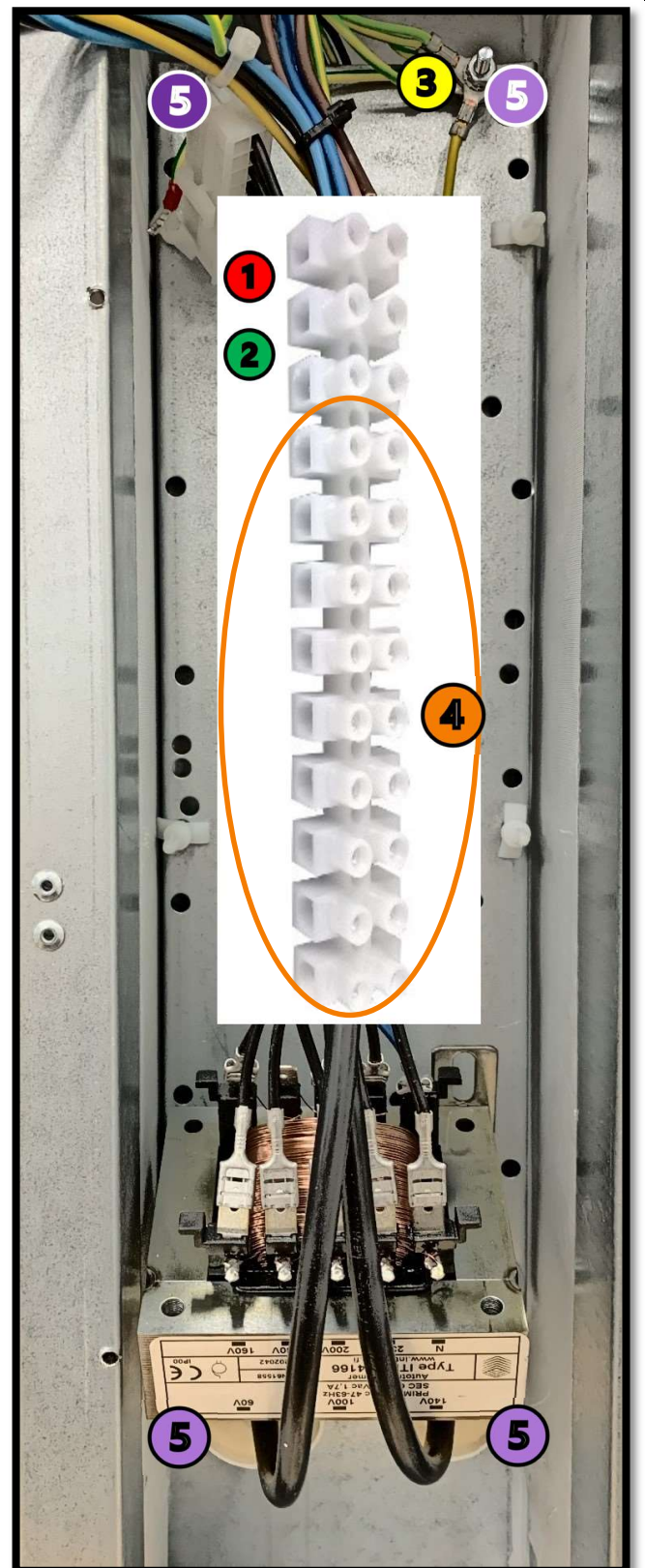

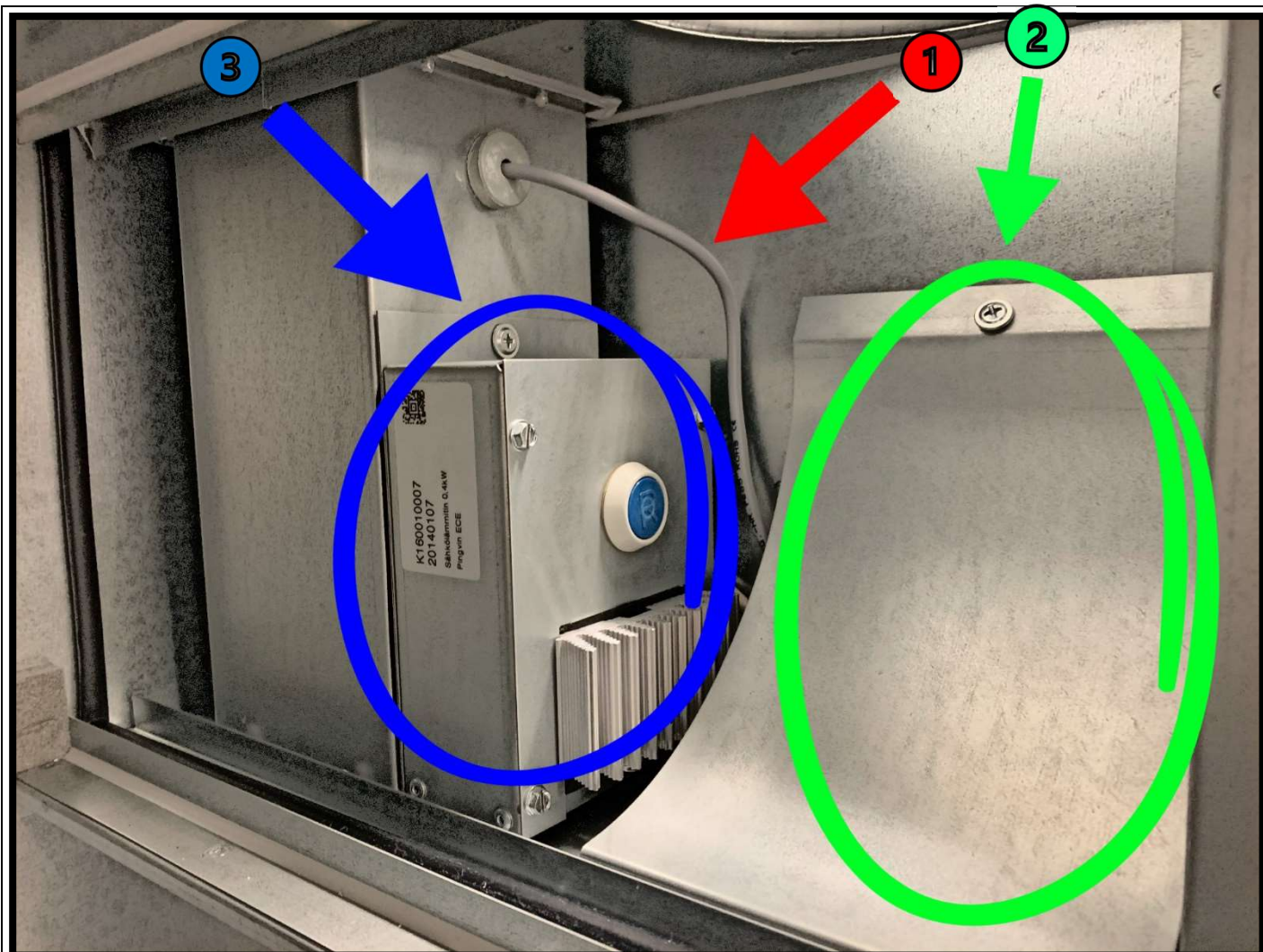

Remove **the sensor (1)**. *Ignore if the unit doesn't have an after heater installed.*

Remove **the flow helper (2)** (one screw). Reattach the screw.

Remove **the after heater (3)** (one screw). *Ignore if the unit doesn't have an after heater installed.*

Disconnect and remove **the connectors (1)** from the cables.

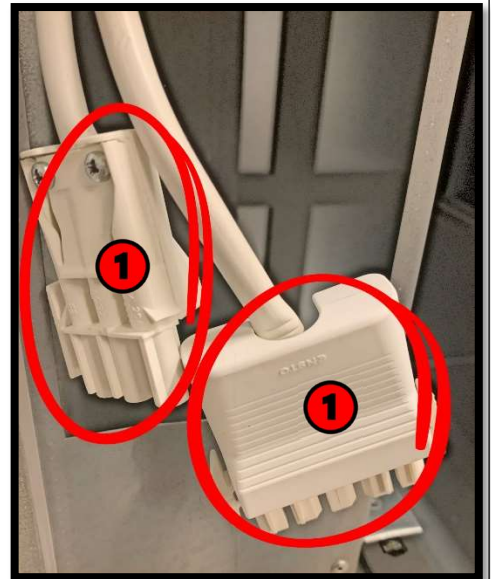

Cut and remove **the ground wire (green/yellow) (1)** from the cable with **FOUR WIRES (2)**.
Cut and remove in the other end also (in the electrical box).

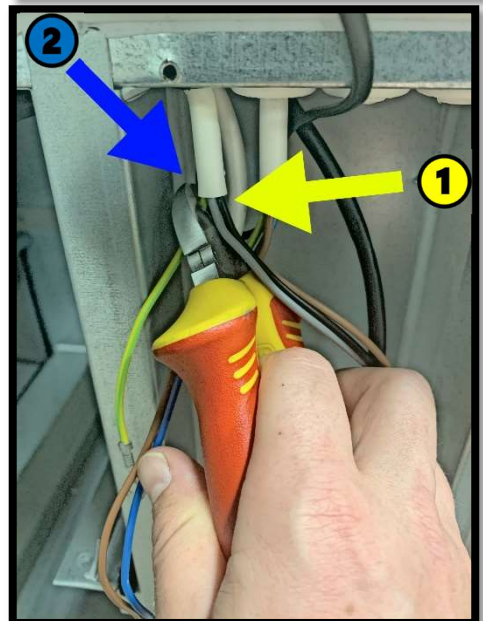

Connect **the removed 3-pin connector to the cable.**

- 1: Brown (1)
- GND: Black (2)
- N: Gray (3)

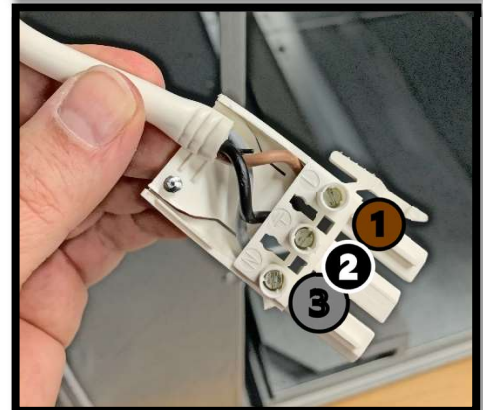

Connect **the delivered 3-pin connector (40029346)** to the other cable.

1: Brown (1)

GND: Green/yellow (2)

N: Blue (3)

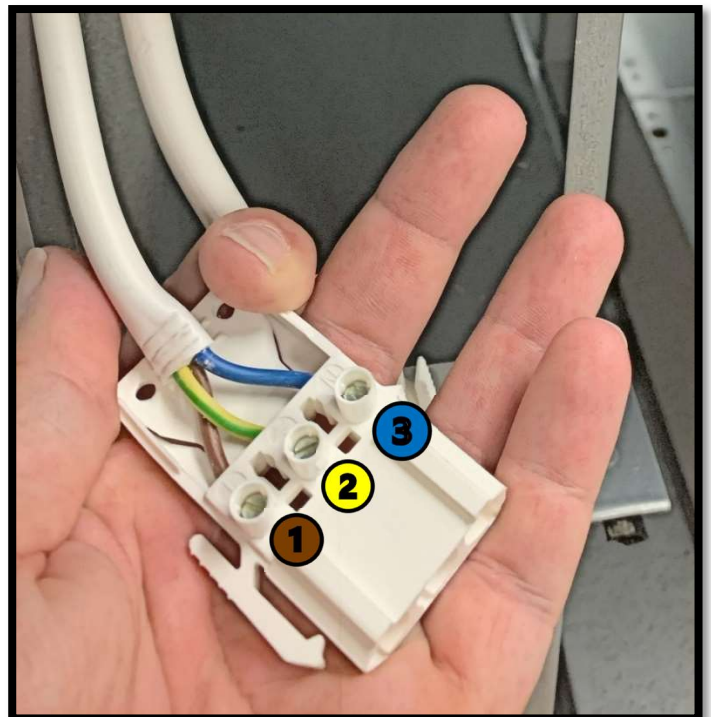

If there is a pre-heater installed inside the unit, connect it to this connector also.

1: Brown (1)

GND: Green/yellow (2)

N: Blue (3)

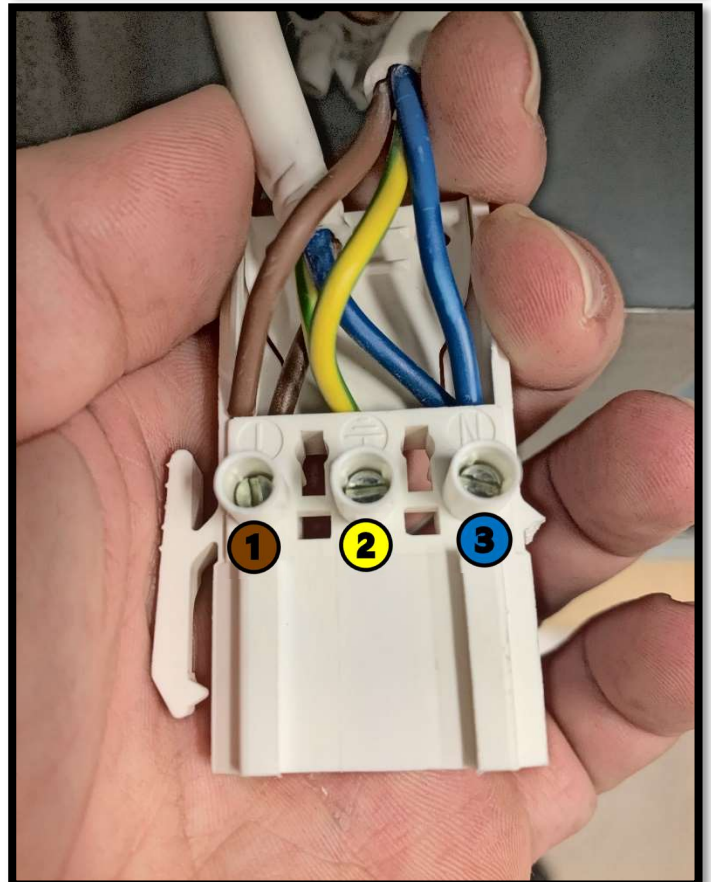

Close **the connectors** with their caps (two screws).



Attach **the adapters (1)** (40028768) (40029530).

- **Make sure that the supply power cable (brown, green/yellow, blue) (230VAC) is connected to the adapter with the 4-pin Molex connector!**
- **Make sure that the signal cable (gray, black, brown) (0-10VDC) is connected to the adapter with the 3-pin Molex connector!**

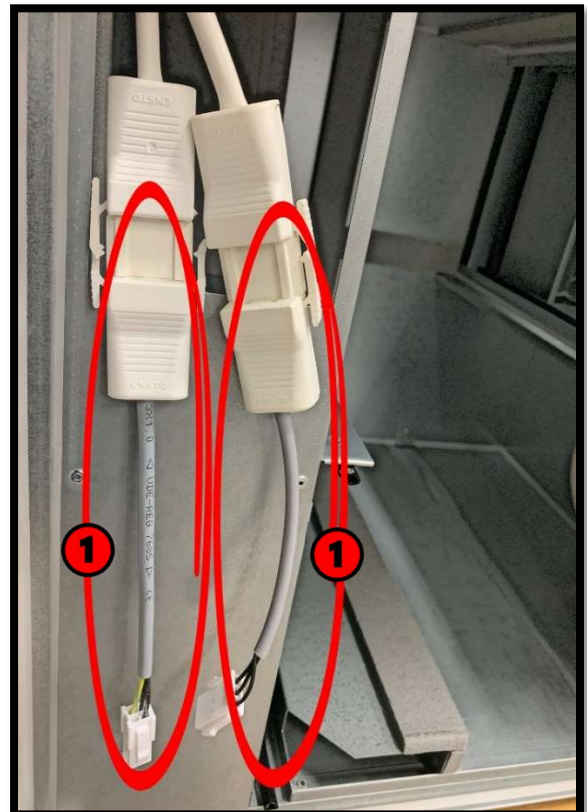

Remove **the supply air fan cable (1)**.

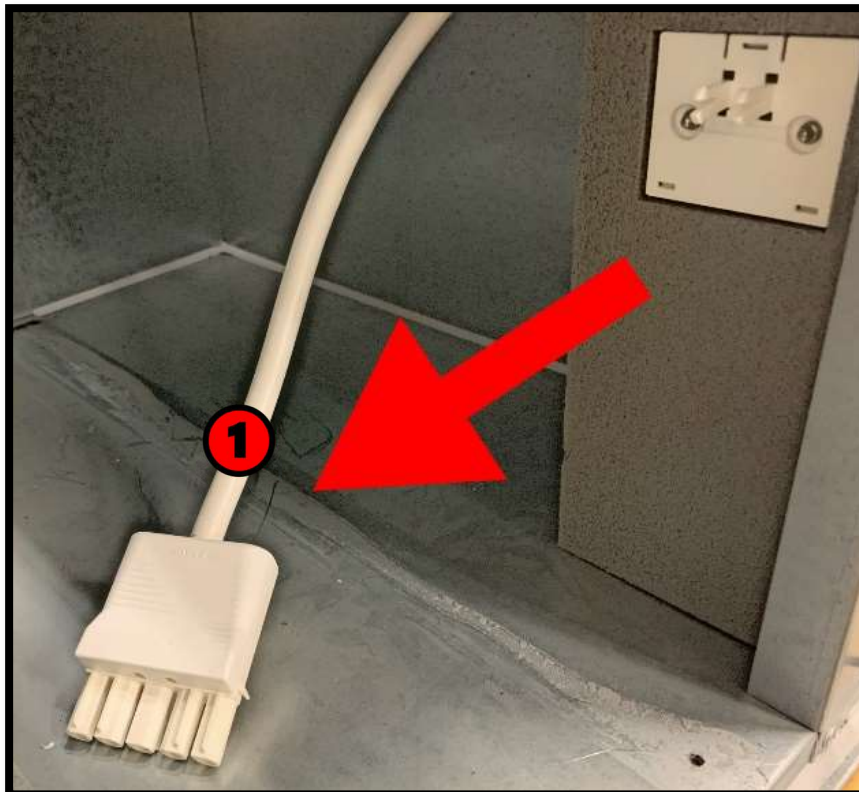

Replace **the used cable sealings (1)** with new ones (40030101).

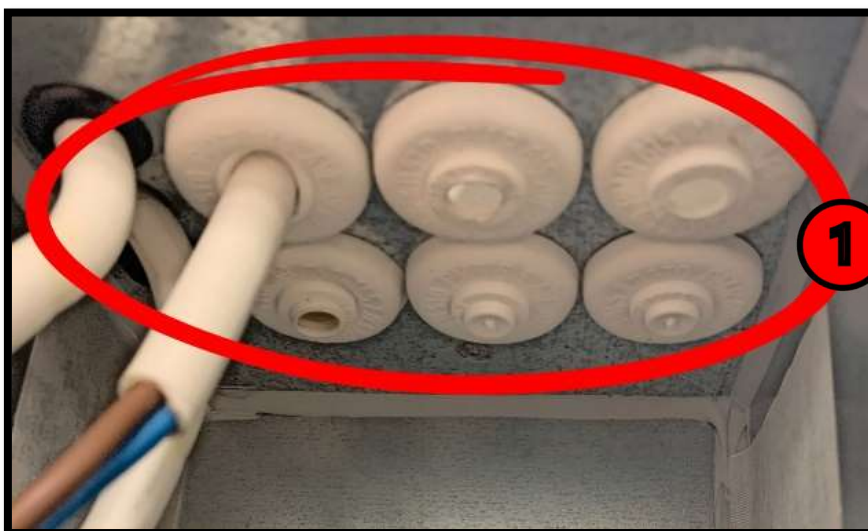

Install **the new supply air fan cables (1)**
(40028783) (40028785)
(through a cable sealing in the electrical box).

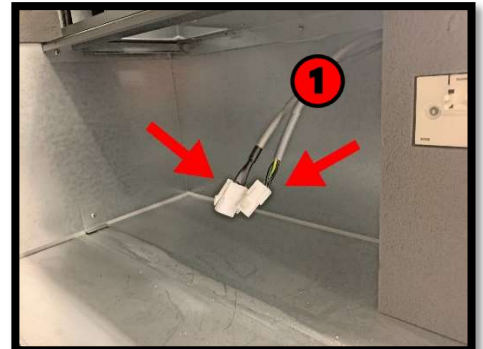

Install **the new sensors (1)**
(40029165) (40029166) (40029167)
(through a cable sealing in the electrical box).

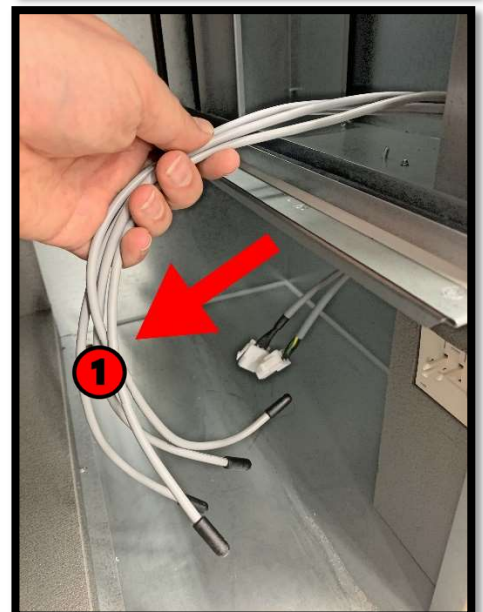

New cables installed in the electrical box.



Install **the HRW supply air sensor (850mm) (1)** (40029165).



Mark it **"TE05"** on **the connector (1)** in the other end.

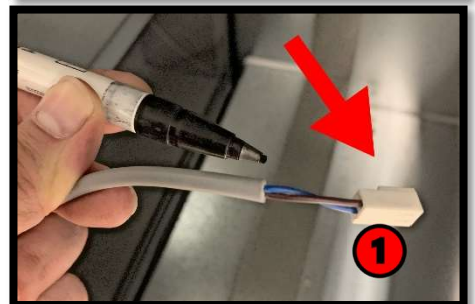

Attach the sensor(s) to the cable sealing with **a cable tie (1)**.



HRW supply air sensor installed (1).

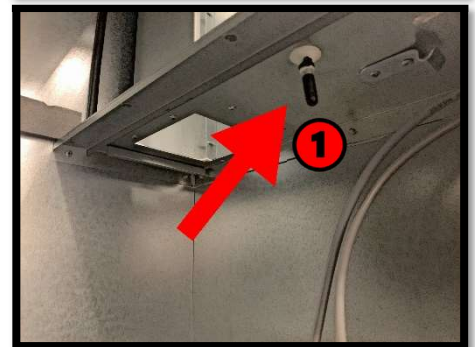

Install **the supply air sensor (1100mm) (1)** (40029166) and mark it "TE10" on the connector in the other end.

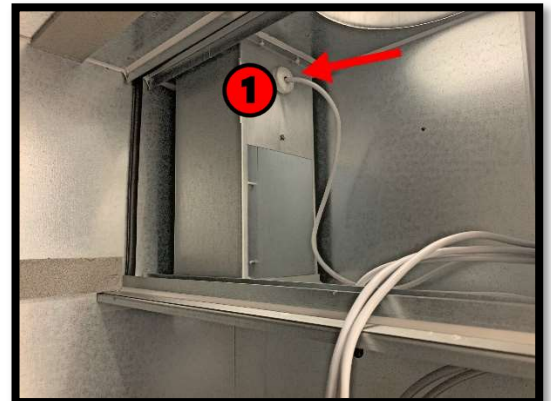

Cut a 10mm gap in **the black rubber sealing (1)**.



Cut a small gap, all the way, in **the gray rubber sealing (1)**, from right to left.

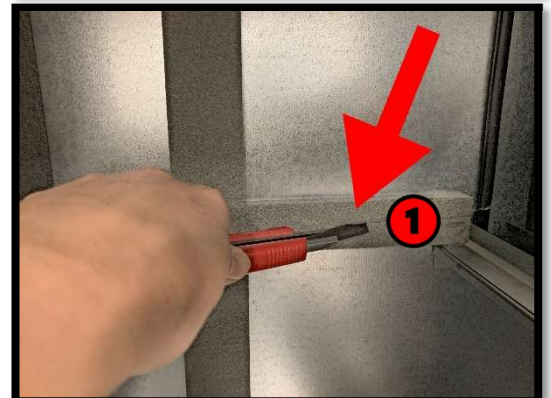

Cut a small gap in **the gray rubber sealing (1)**, as marked in the picture.

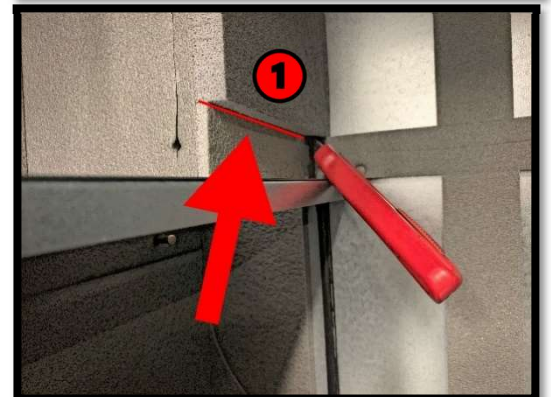

Drill a **16mm hole (1)** as marked in the picture.



Install **the outside air sensor (1700mm)** (40029167) in the gaps of the rubber sealings and in its **final place (1)**. Mark it **"TE01"** on the connector in the other end.

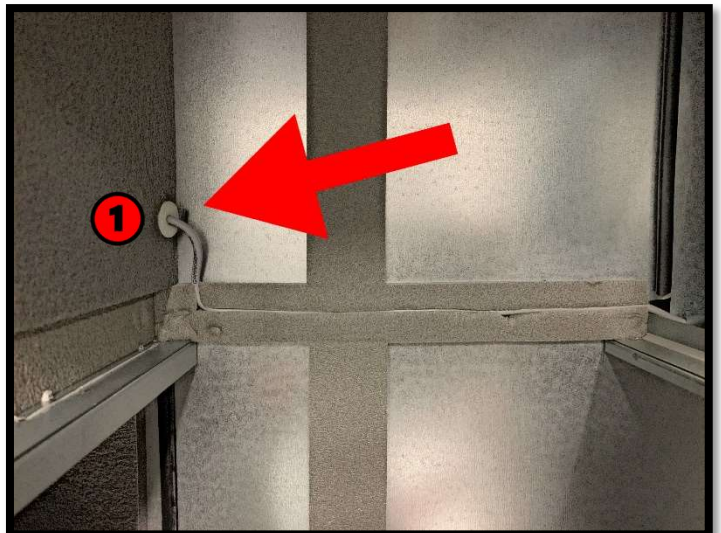

Cut another small gap, all the way, in **the gray rubber sealing (1)**, from right to left.



Install **the waste air sensor (1700mm) (40029167)** in the gaps of the rubber sealings and in its **final place (1)**. Mark it **"TE32"** on the connector in the other end.

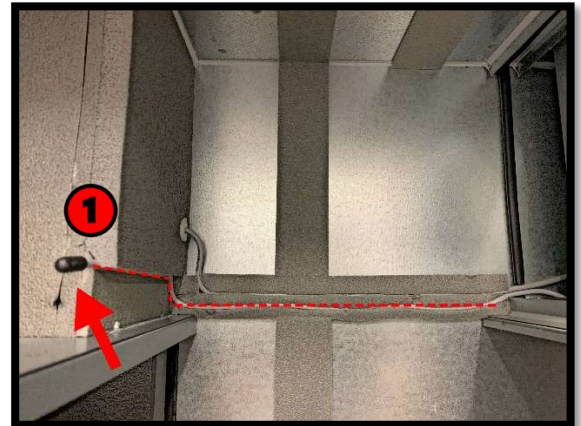

Put **sealant (1)** in the gap. ex. *Würth silicone sealant*.



Install **the new after heater (3) (10023244)**. Leave **the flow helper (4)** uninstalled and attach the cables together with cable ties.

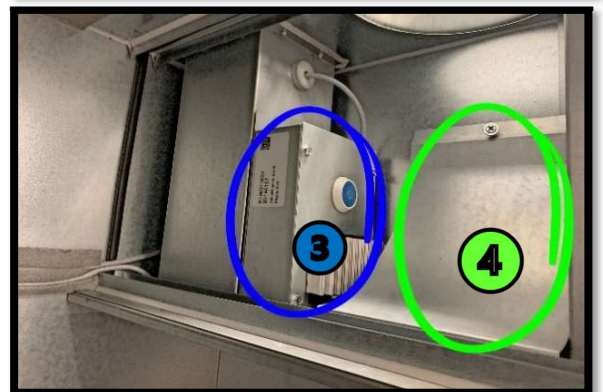

Install **the after heater cables (1)**
(through a cable sealing in the electrical box).

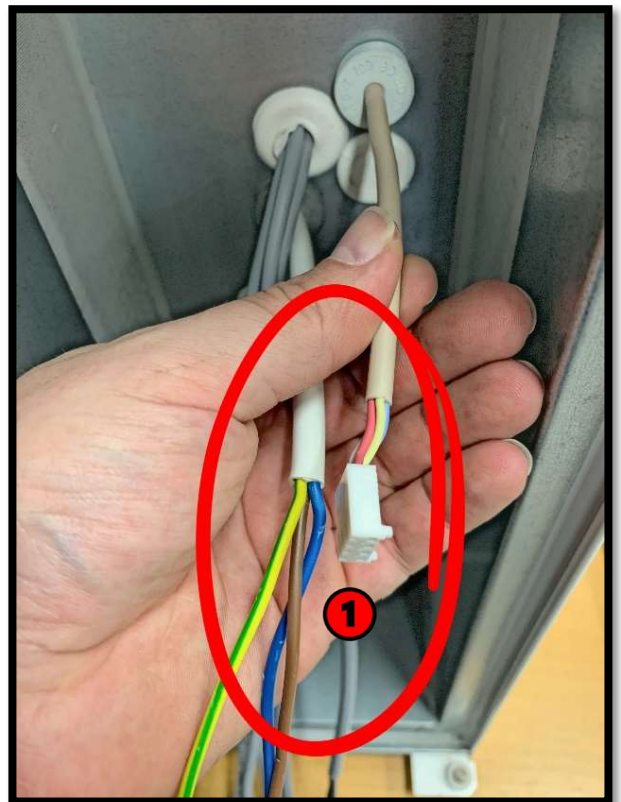

Drill **a 18mm hole (1)** as marked in the picture.

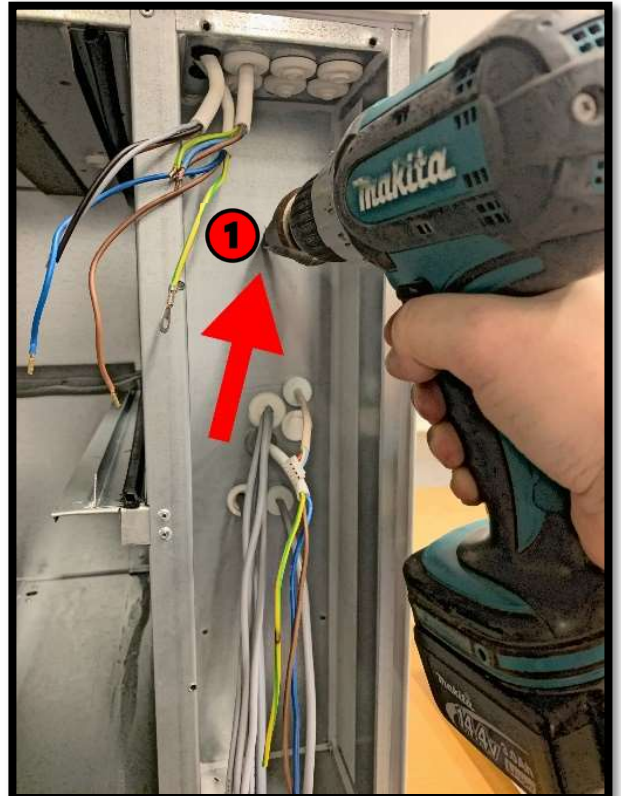

Drill **a 18mm hole (1)** as marked in the picture.



Install **the HRW cable (1)** (40033952) (through a cable sealing in the electrical box).



Install **the extract air sensor with a cable sealing (1)** (40029224), through the drilled hole in the electrical box.

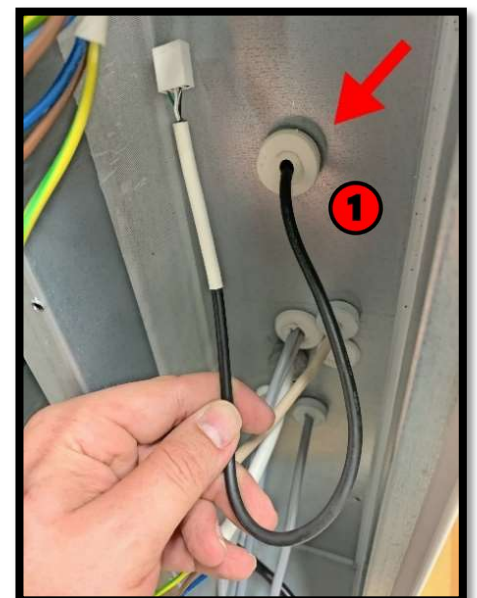

Install **the new automation** in the electrical box.

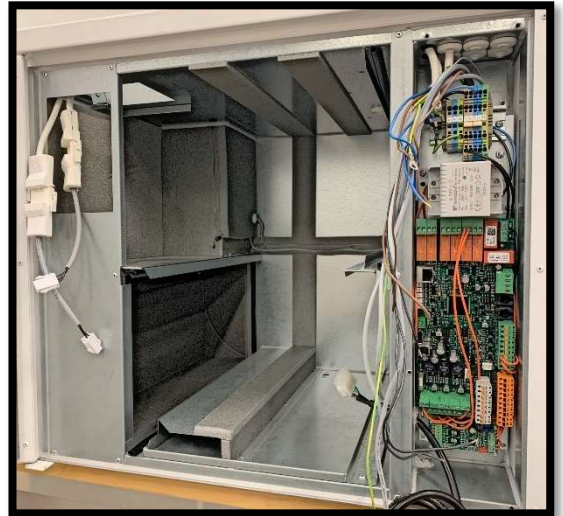

Make sure no **installed cable / sensor** get stuck behind the automation base and that they are available in front of the main board.

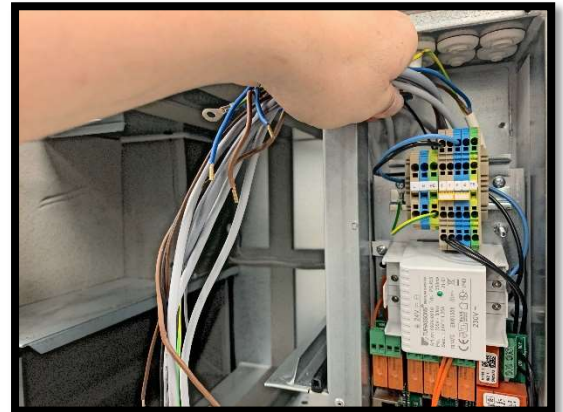

Attach **the automation base** (40029647) to the electrical box with **four self tapping screws (1)** (40031530).

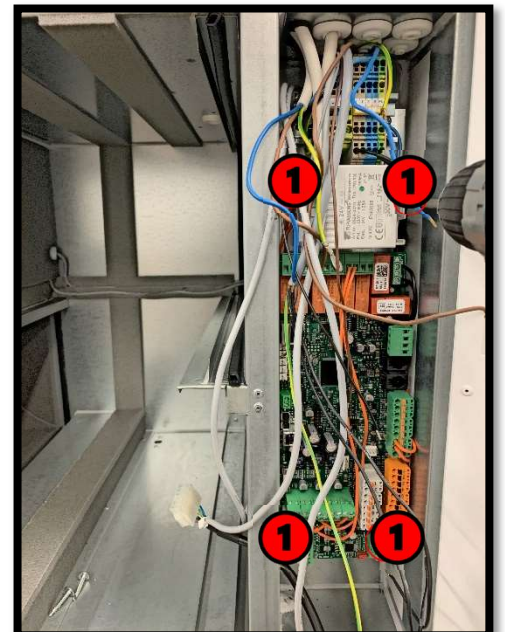

Connect **the power cord to the terminals (1)**.

L: Brown

PE: Green/yellow

N: Blue

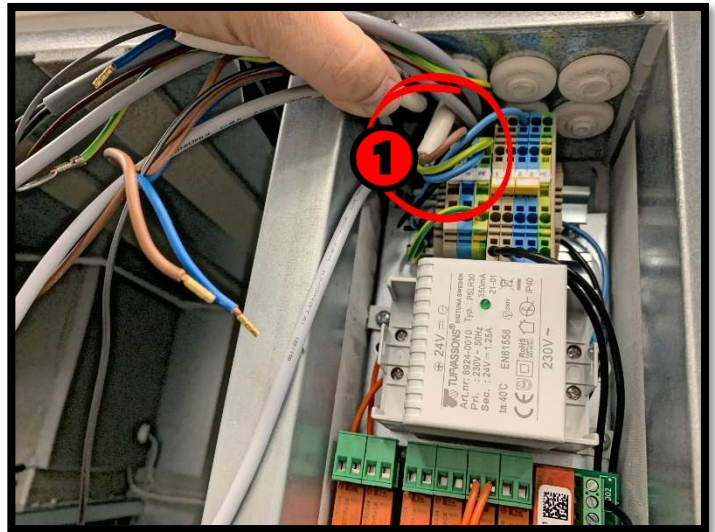

Connect **all ground wires to the automation base ground point (1)**.

Supply air fan, extract air fan, after heater, ground terminal.

Totally four wires. **Three wires if no electrical after heater installed.**

Connect the cover ground wire to the ground terminal (PE).

Tighten with **the nut (40031489)**.

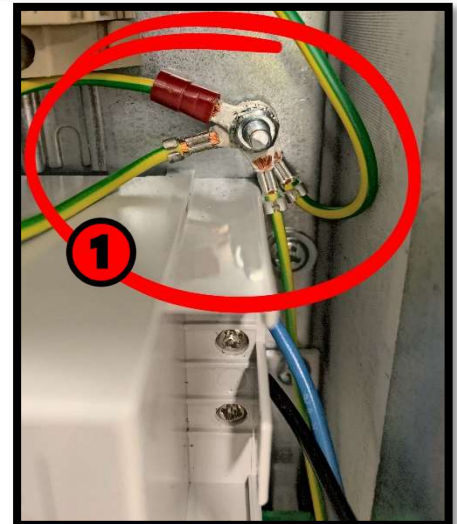

Connect **the blue wire** from the electrical after heater to **the blue "2" connection terminal (2)**.
Ignore if the unit has a water coil after heater installed.

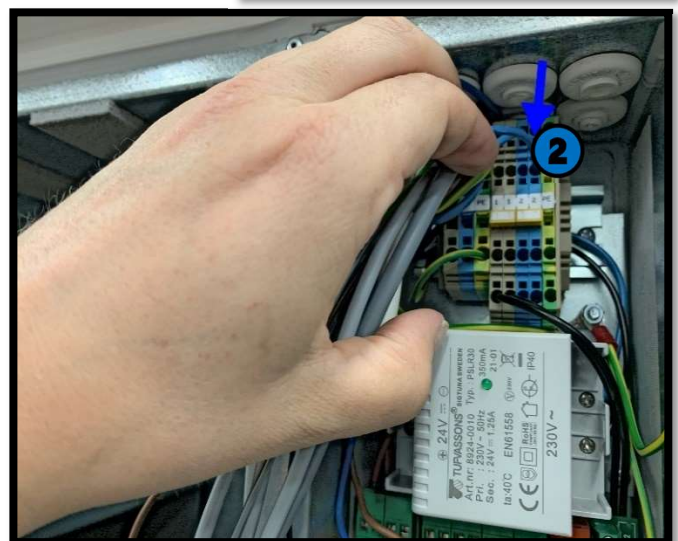

Connect **the brown wire** from the electrical after heater to **"DO2" (2)**.
 If there is a water coil after heater installed, the circulation pump power wire (L) would be connected here.

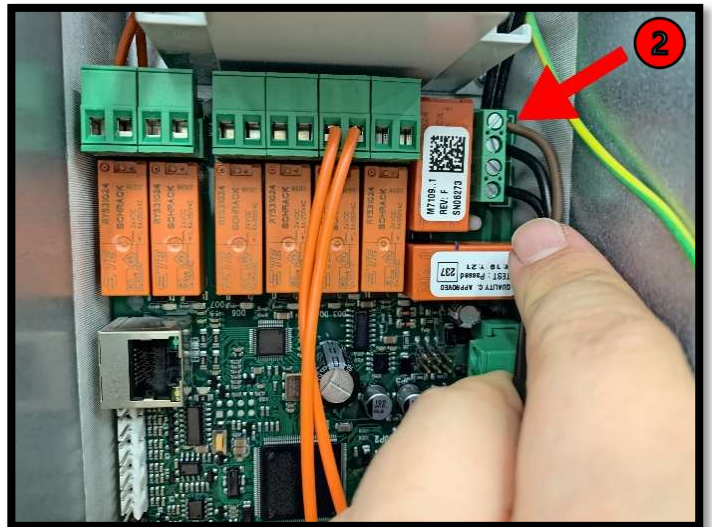

Connect **the blue wire** from the extract air fan power cable to **the blue "2" connection terminal (2)**.

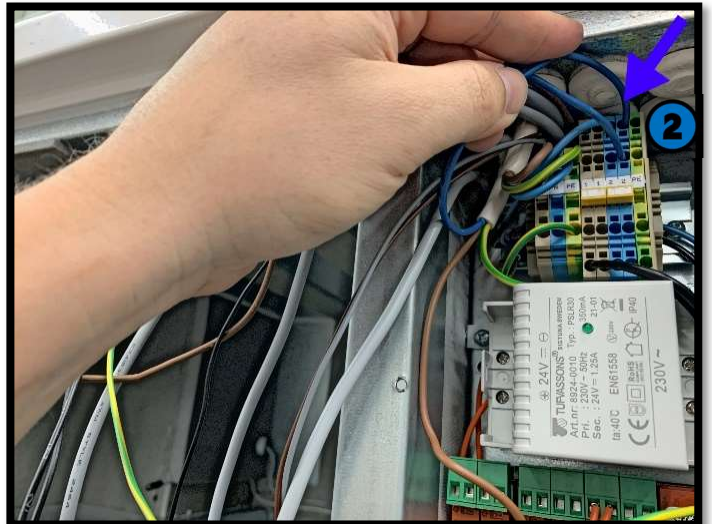

Connect **the black wire (40028776)** to **"DO1" (1)** and to **the connection terminal (2) (40029982)**.

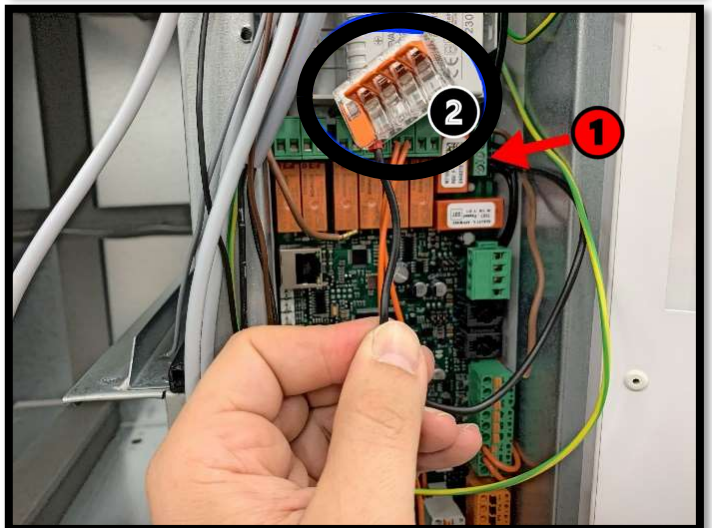

Connect **the brown wire (2)** from the extract air fan power cable and **the wire marked "1"** (1) in the supply air fan power cable to the connection terminal (40029982).

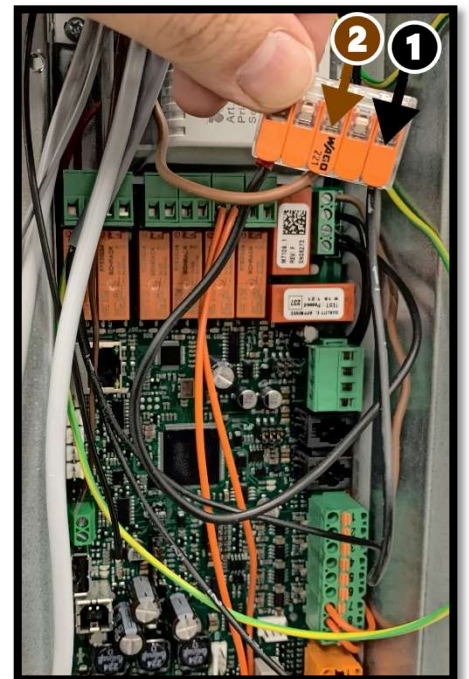

Connect **the wire marked "2"** (2) from the supply air fan power cable to the **blue connection terminal**.

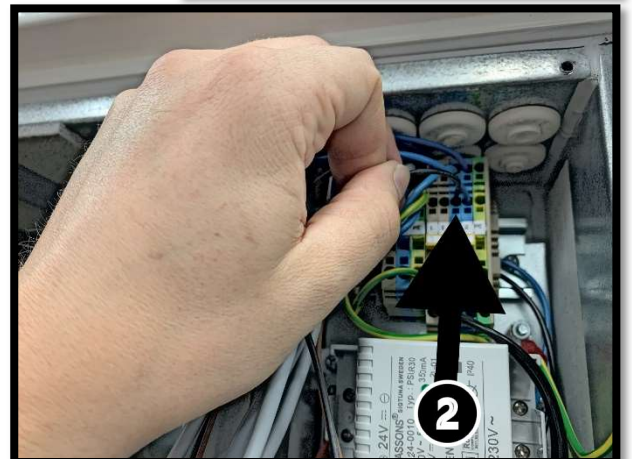

Connect **the extract air sensor (1)** (40029224) to the main board (X29).

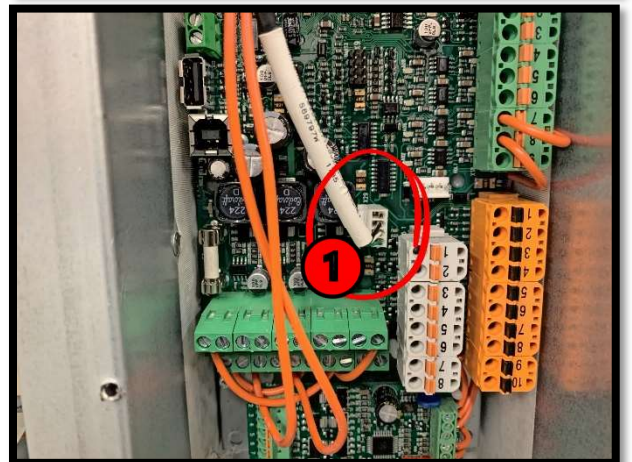

Connect **the sensors (1)** to the main board according to the markings.

- X1, TE01: Outside air
- X2, TE05: HRW supply air
- X3, TE10: Supply air
- X4, TE32: Waste air
- X12, TE45: Return water sensor (2),
if the unit has a water coil after heater installed.

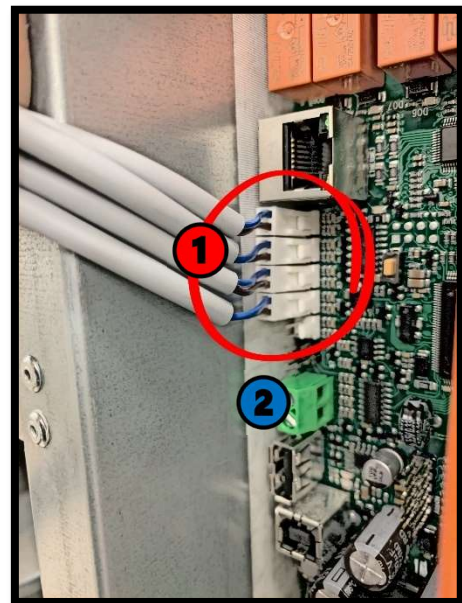

Connect **the wires from the supply air fan control cable (1)** (40028785) to the main board.

- 1: Brown
- 2: Black
- 3: Gray

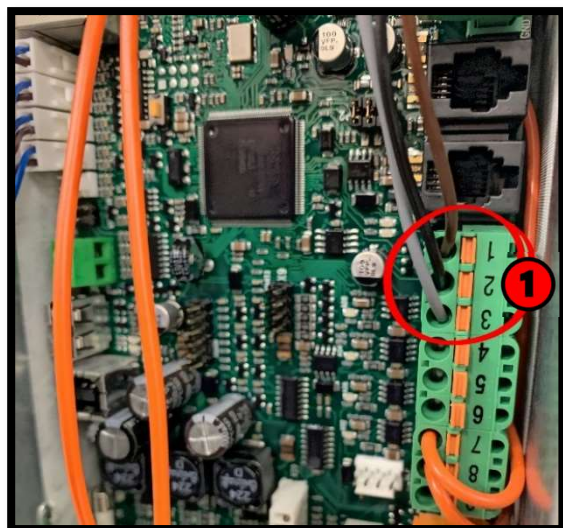

Connect **the wires from the extract air fan control cable (1)** to the main board.

- 4: Brown
- 5: Black
- 6: Gray

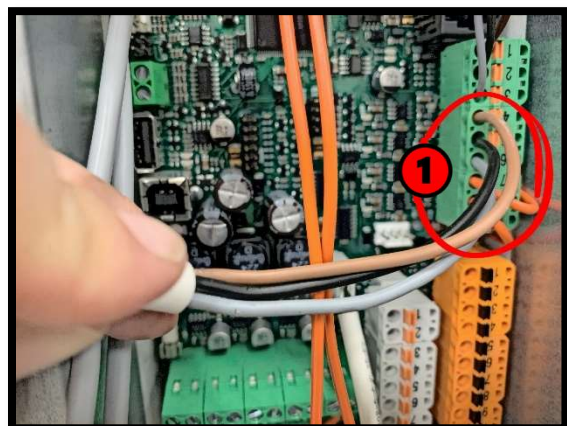

Release **the screw (1)** and attach **the ground wire (2)** from the HRW cable to the screw, along with **a washer (40031537)**.

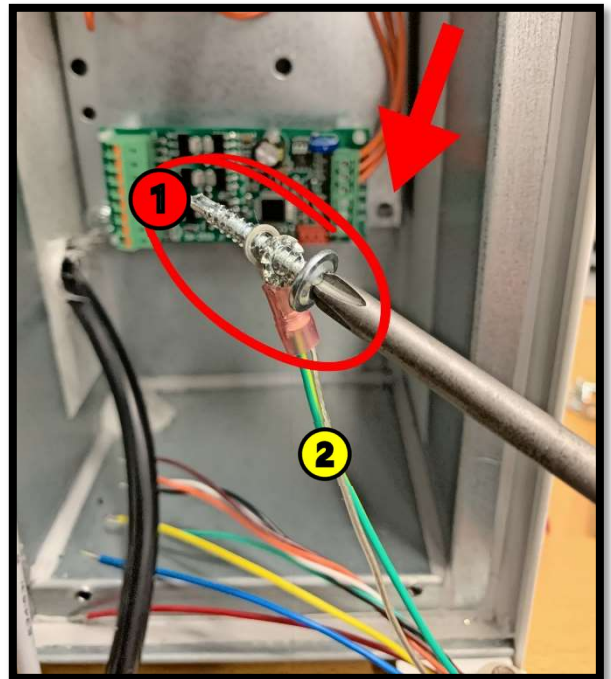

Reattach **the screw (1)** to the automation base.

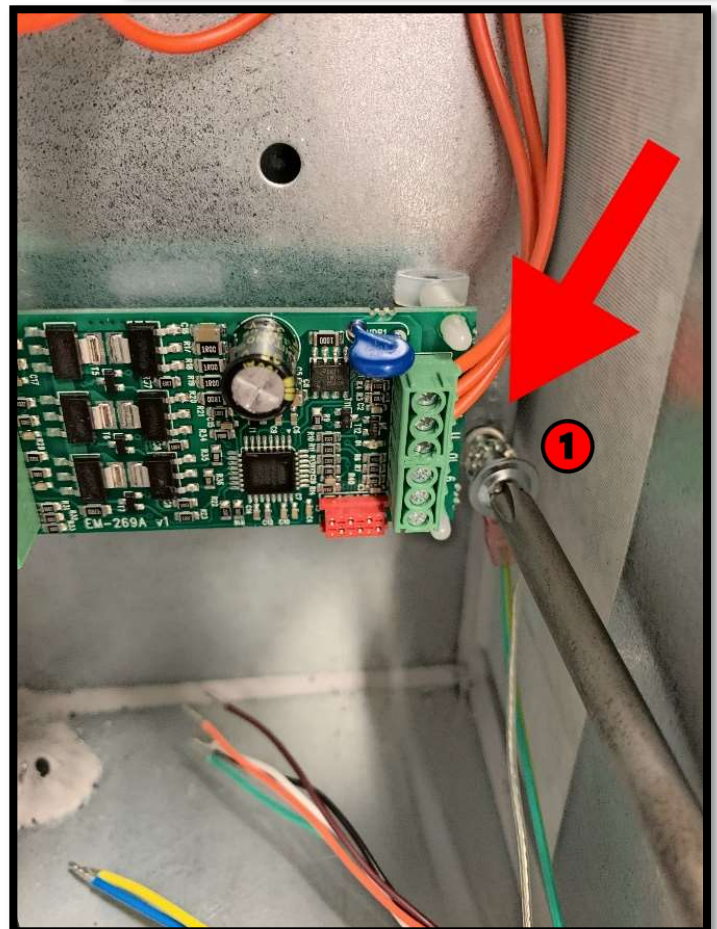

Connect **the wires from the HRW cable (40033952) to the HRW control board (1).**

1: Yellow

2: Red

3: Blue

4: White

5: Black

6: Brown

7: Green

8: Orange

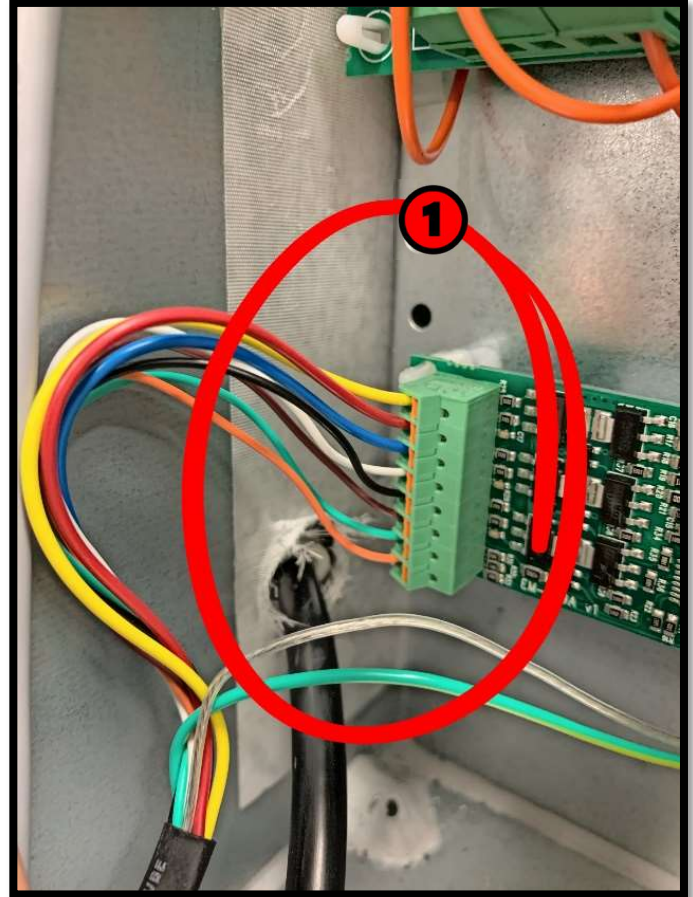

Connect **the after heater control cable (1)** to the main board (X17).

Ignore if no electrical after heater installed.

Connect other components (for example actuator for cooling coil) according to the electrical diagrams (pages 34-37).

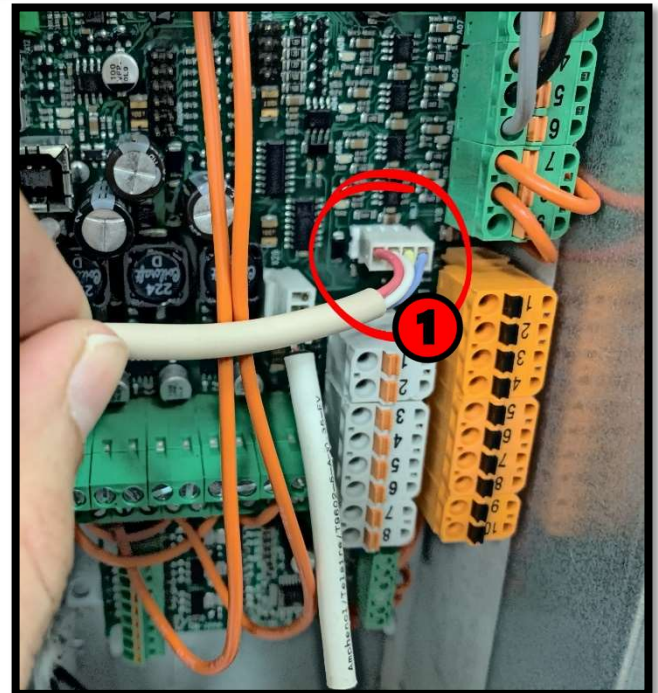

Connect **the pairs of wires with flat connectors** (40028776, 40028777) to the main switch and to the connection terminals.

L: Black (3)
N: Blue (4)

1: Black (1)
2: Blue (2)

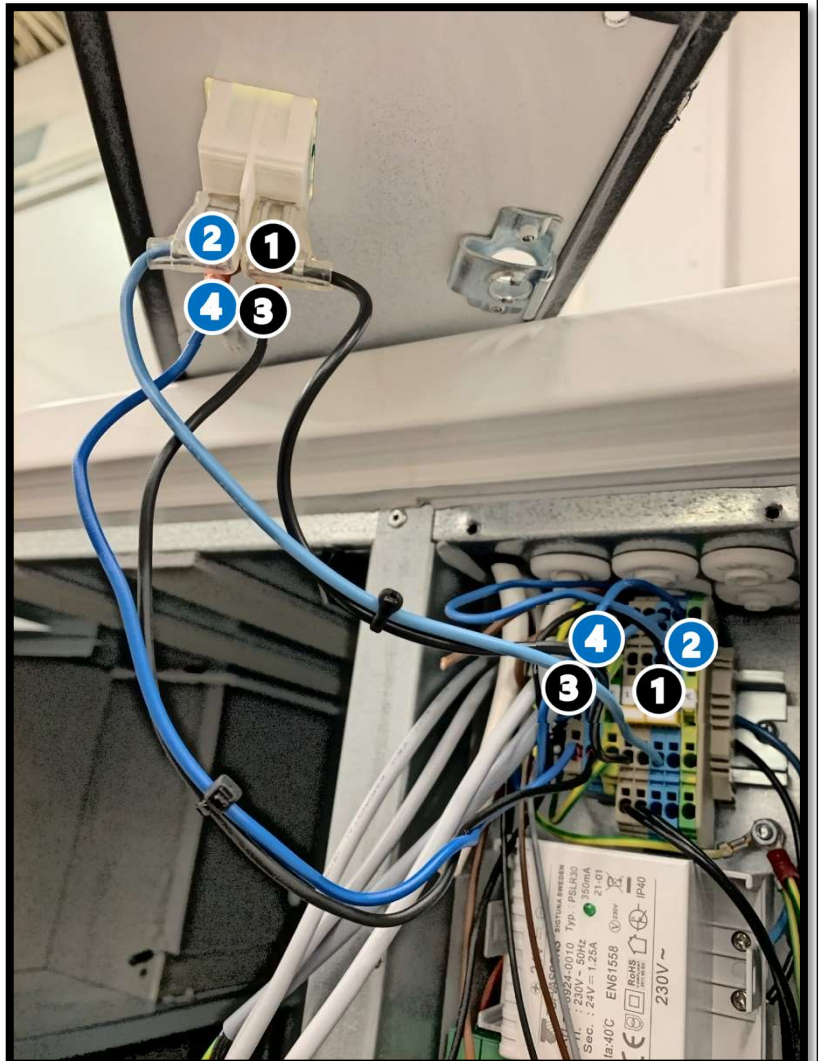

Connect **the ground wire (1)** to the cover.

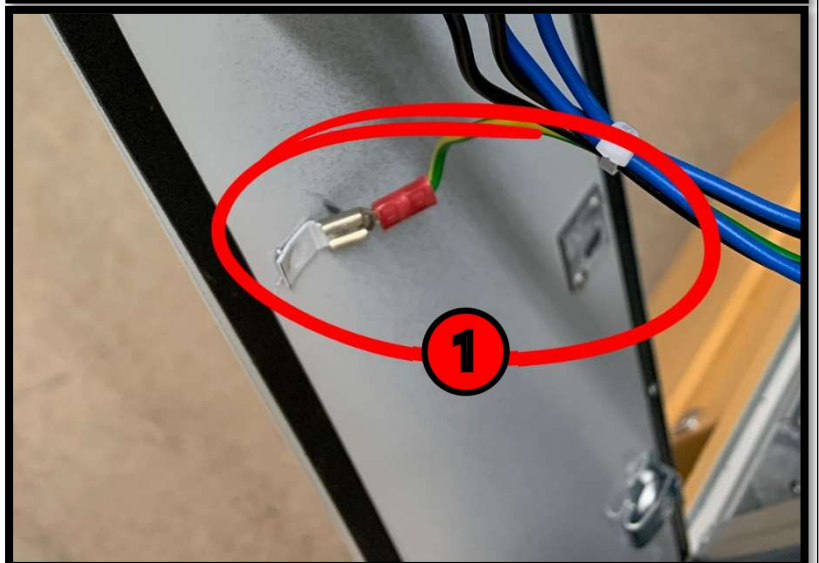

Install **the new extract air fan (1)** (10023126).

Attach **the pin (2)**.

Connect the cables to the adapters (3).

- Make sure that the supply power cable (brown, green/yellow, blue) (230VAC) is connected to the adapter with the 4-pin Molex connector! **DO1 / N at the main board!**
- Make sure that the signal cable (white, blue, yellow) (0-10VDC) is connected to the adapter with the 3-pin Molex connector! **A02 / GND / DI12 at the main board!**

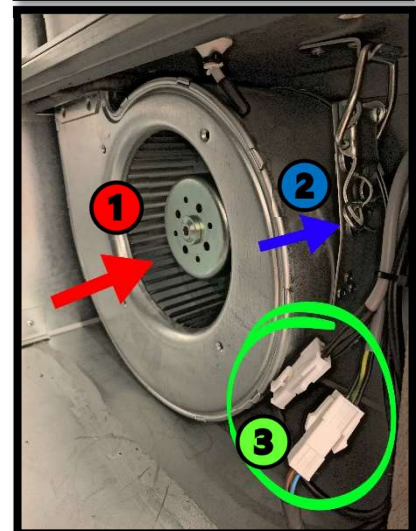
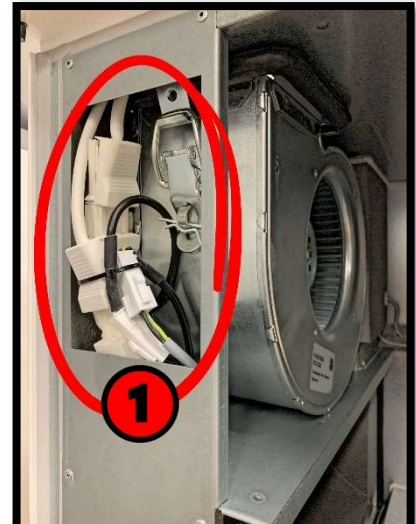
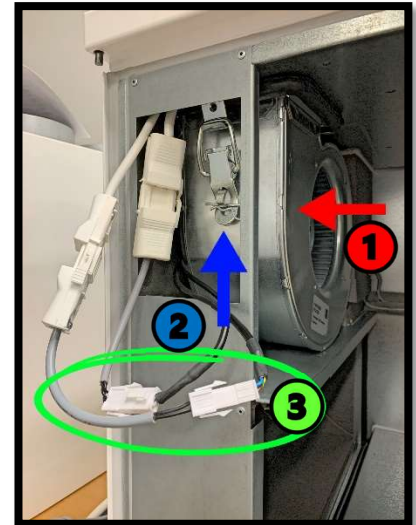

Attach the cables together with a cable tie (1).

Install **the new supply air fan (1)** (10023125).

Attach **the pin (2)**.

Connect the cables to the connectors (3).

Attach the cables together with a cable tie.

Install **the filter rail (1)** and attach **the screw (2)**.
A filter can't be used here anymore because of the HRW cable.

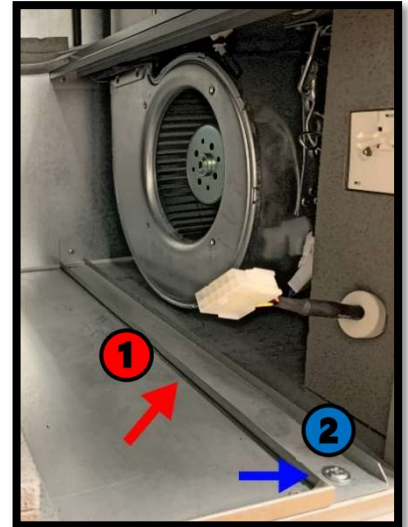

Remove **the screws (1)** from the HRW cover.



Remove **the belt (1)** from the wheel.
Remove **the screws (2)** from the motor package.
Remove **the ground wire (3)**.

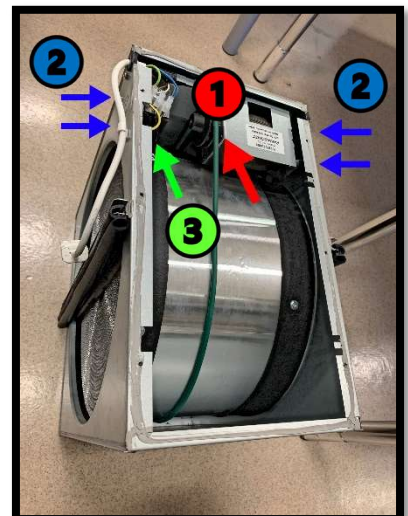

Remove **the motor package**.
Cut a gap for the new motor cable.
Remove **the rubber sealings (1)**,
carefully so the brush clips underneath won't come off.

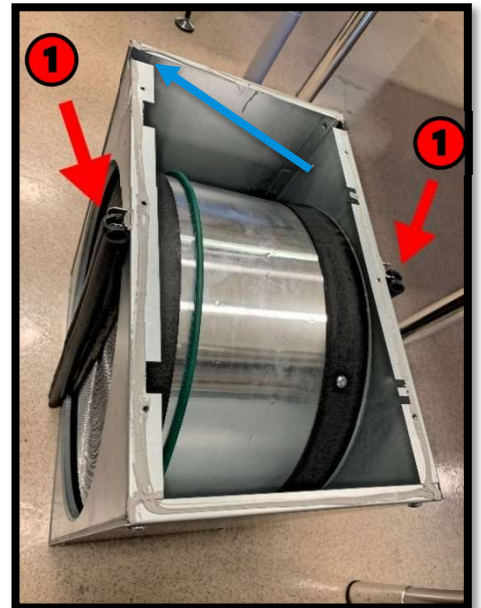

Install **the new motor package (2)** (40028737).
Install **the rubber sealings (1)** on the opposite side of the brush rail.
Attach the cover with the screws.

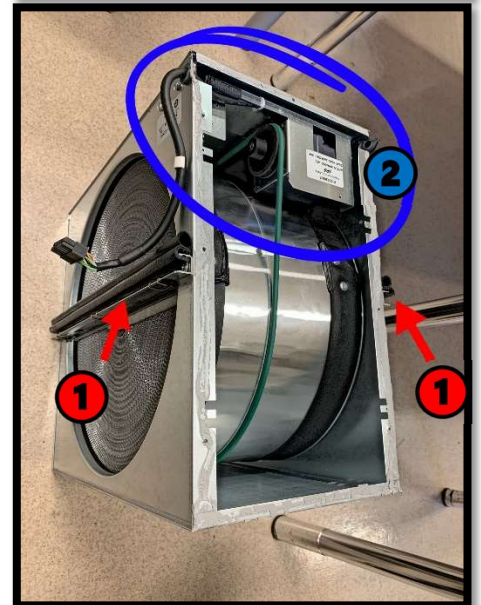

Install **the HRW (1)** and **the filters (2)**.

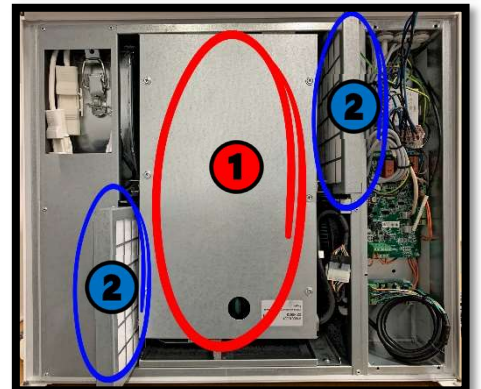

Connect **the display cable (1)** to the main board.

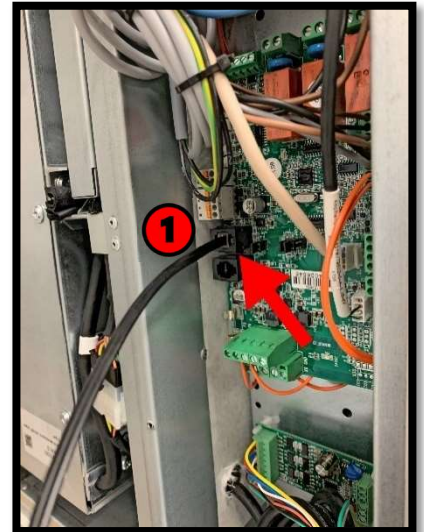

The display cable can be installed either through the cable sealings in the electrical box, or through **the hole in the cover (1)**. The old display cable may also be used, but the joints has to be done carefully and in a proper way. Close the cover of the electrical box.

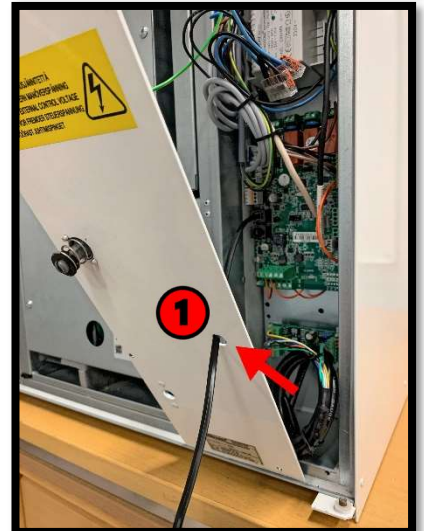

Install **the new display (2)** (40031114) in a desired place.



Install **the WiFi module (3)** (40034288).



Turn on **the main switch (1)** and perform insulation and ground continuity test according to regulations.

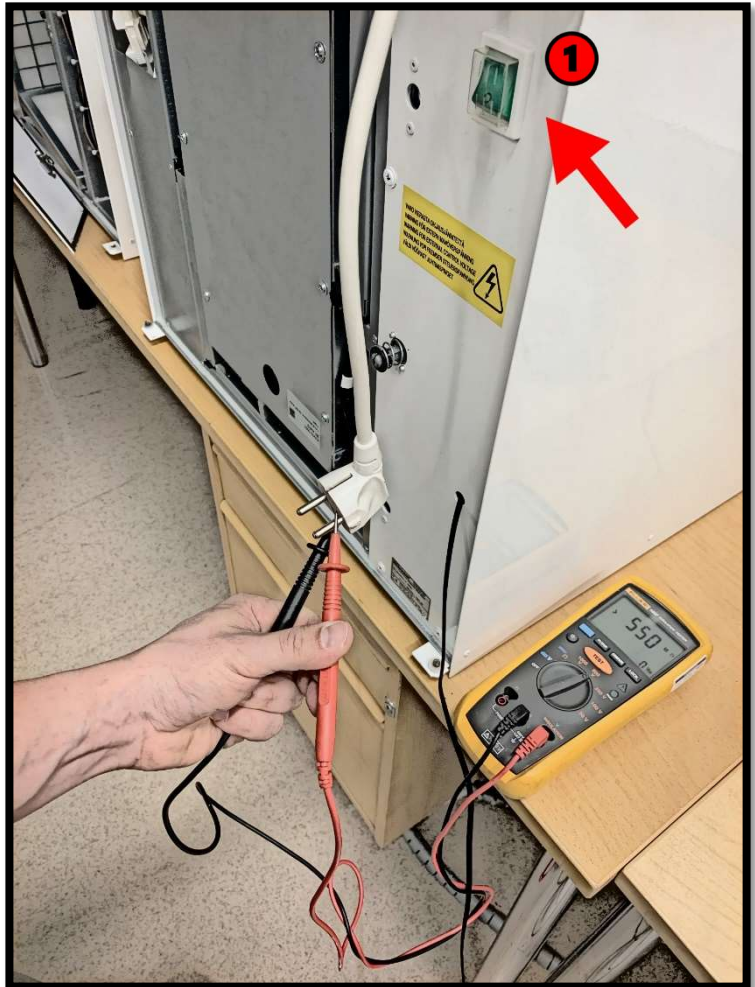

Install the doors by lifting **(upper part first) (1)** so that the lower edge rises above **the pins (2)** and gets into place.

Install **the new type plate sticker (3)**.

Close the doors.

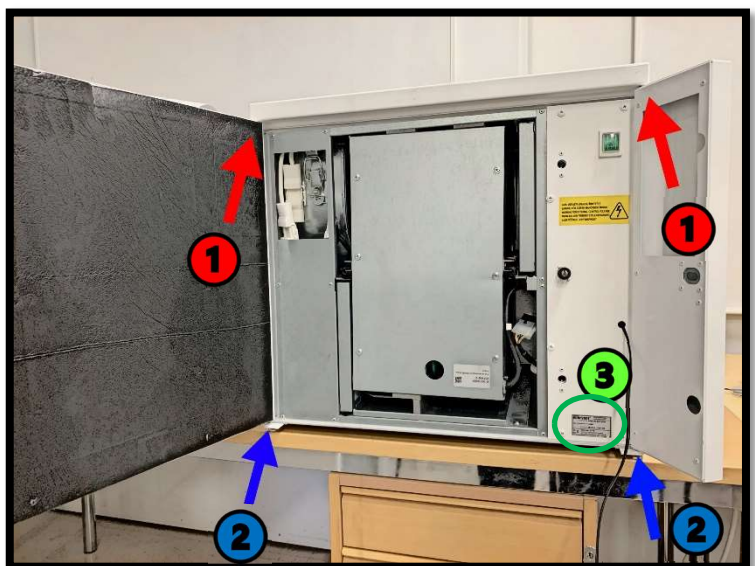

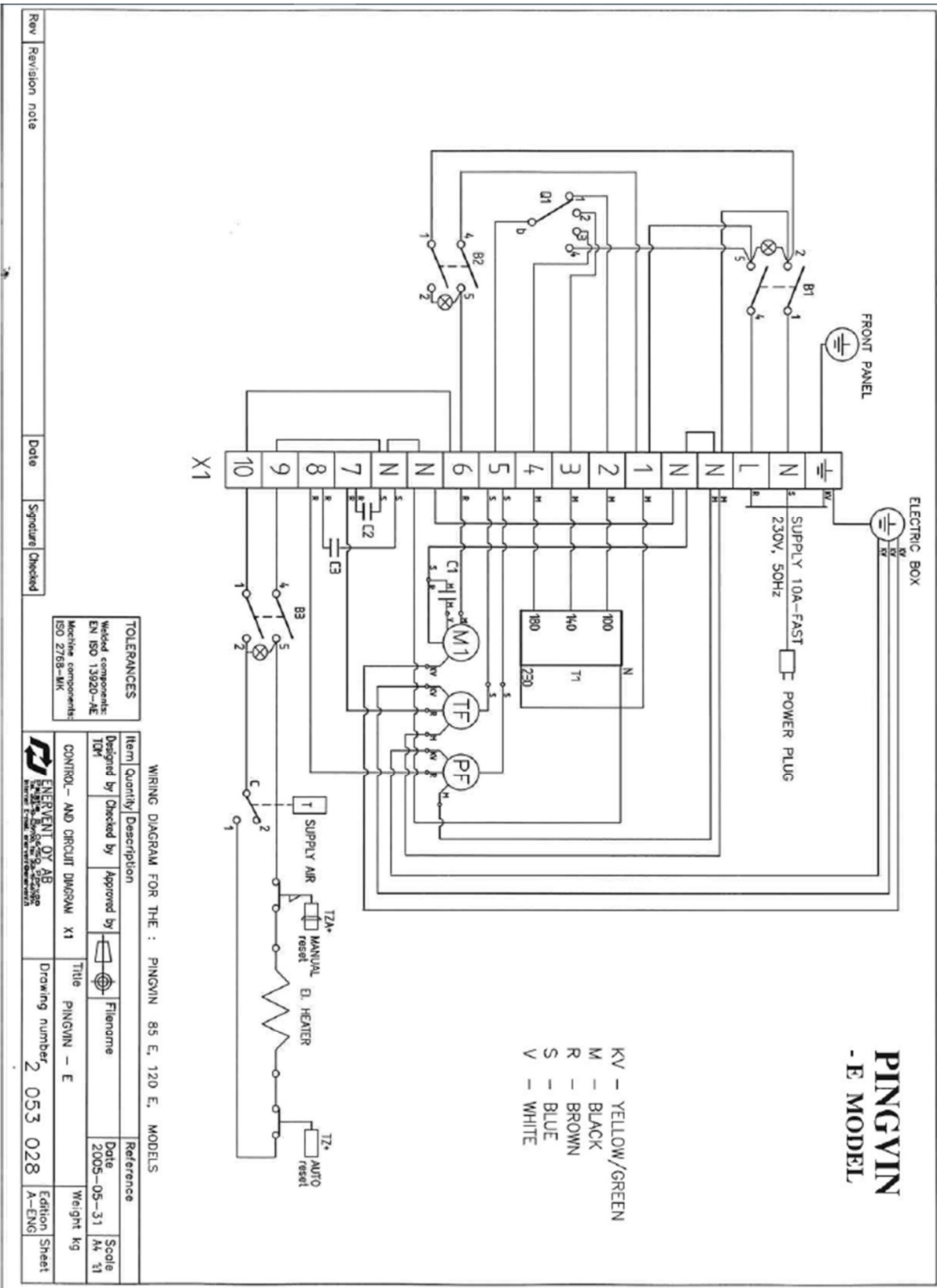

Rev	Revision note	Date	Signature	Checked

TOLERANCES
 Welded components:
 EN ISO 13920-2E
 Machine components:
 ISO 2768-MK

Item	Quantity	Description	Designed by	Checked by	Approved by	Reference	Scale

WIRING DIAGRAM FOR THE : PINGVIN 85 E, 120 E, MODELS

Item	Quantity	Description	Designed by	Checked by	Approved by	Reference	Scale
CONTROL - AND CIRCUIT DIMSVM X1							

File name: PINGVIN - E

Item	Quantity	Description	Designed by	Checked by	Approved by	Reference	Scale
Drawing number	2 053 028						

Weight kg

Item	Quantity	Description	Designed by	Checked by	Approved by	Reference	Scale
Edition	A-EN6						

Sheet

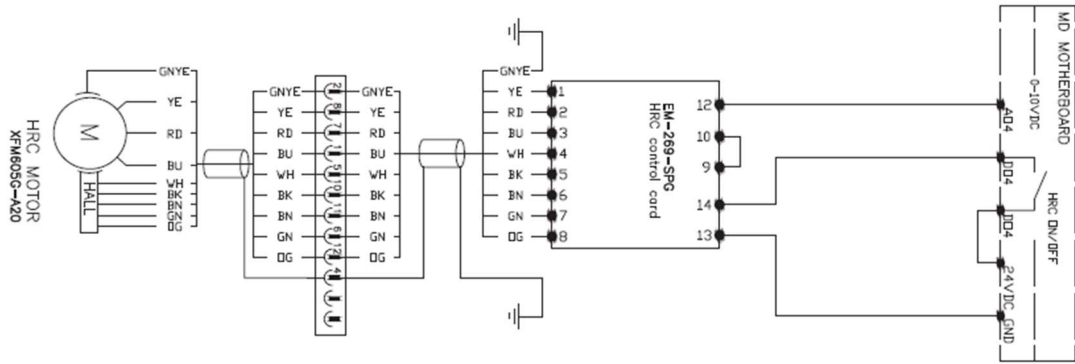

WIRE COLOURS

BLACK	—	BK
BROWN	—	BN
RED	—	RD
ORANGE	—	OG
YELLOW	—	YE
GREEN	—	GN
BLUE	—	BU
GREY	—	GY
WHITE	—	WH

Appr by

Drawn by	Check by	Appr by	File no	Appr by	Page
MK				30.08.2013	2
MD Control			Name	Weight kg	
HRC schematic			ELECTRIC DIAGRAM		
Ensto, Enervent Oy			AHU		
Kipinätie 1 RN-06150 Porvoo			UNIT'S INTERNAL CONNECTIONS		
Tel. +358 207 528 800 enervent@ensto.com			Change Sheet		
			A 1		

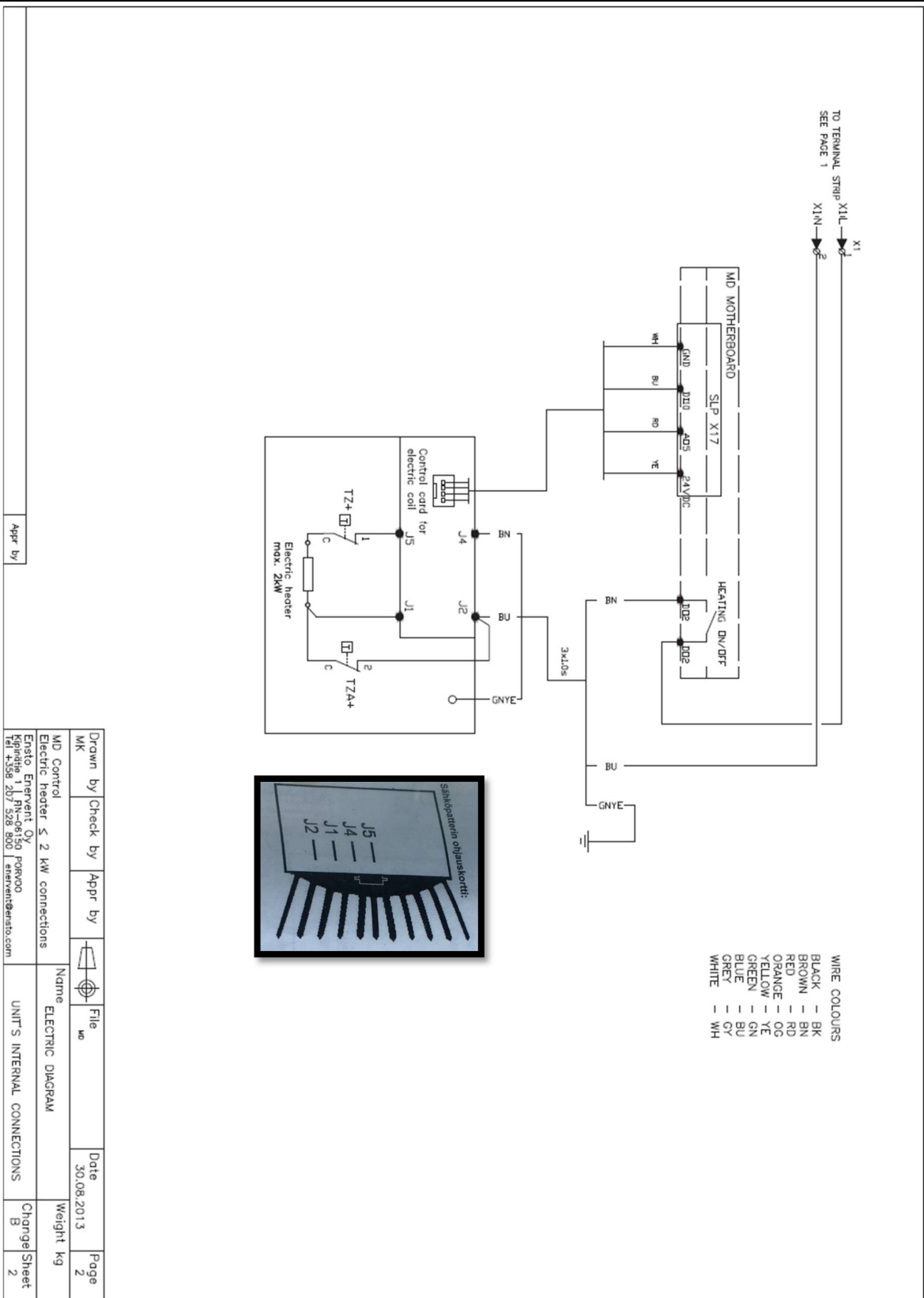

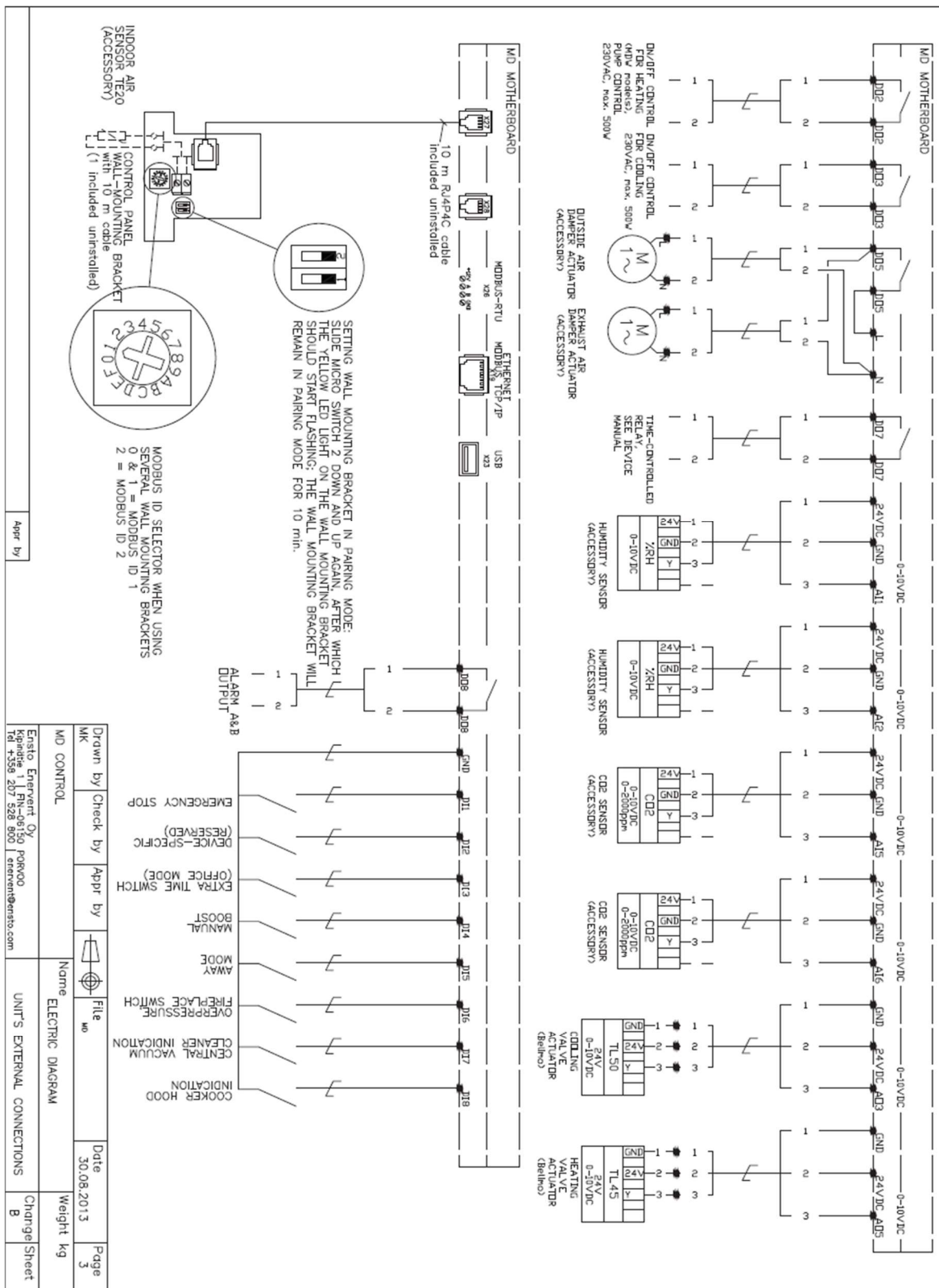

MD CONTROL	File no	Date	Pdge
EMERGENCY STOP		30.08.2013	3
DEVICE-SPECIFIC (RESERVED)			
EXTRA TIME SWITCH (OFFICE MODE)			
BOOST			
MANUAL			
AWAY MODE			
FIREPRESSURE SWITCH			
CLEANER VACUUM INDICATION			
COOKER HOOD INDICATION			

Ensto Enervent Oy
Kipinätie 1 | FIN-06150 PORVOO
Tel +358 207 528 800 | enervent@ensto.com

Apr by

MANDATORY PARTS

10023855	CONTROL UPDATE KIT PING E/ACE/ECE → EAIR E	1
10023125	FAN PACKAGE 118W PINGVIN SUPPLY AIR RIGHT	1
10023126	FAN PACKAGE 118W PINGVIN EXTRACT AIR RIGHT	1
	<i>or</i>	
10023171	FAN PACKAGE 118W PINGVIN SUPPLY AIR LEFT	1
10023170	FAN PACKAGE 118W PINGVIN EXTRACT AIR LEFT	1
10023244	ELECTRICAL HEATER 0,4kW RIGHT	1
	<i>or</i>	
10023243	ELECTRICAL HEATER 0,4kW LEFT	1

Code	Description	Pcs.
10023855	CONTROL UPDATE KIT PING E/ACE/ECE → EAIR E	
	Automation	
40029189	Control board EM-240-M	1
40030936	PCB support KGLS-6S	5
40030937	PCB support LCBSM-6-01	4
40031695	Screw DIN 7981 ZN 3,9x9,5	4
40031631	Screw DIN 7985 ZN M 4x20	1
40031537	Washer 6798-A ZN M 4x8	3
40031489	Nut DIN 934/8 ZN M4	1
40028772	Wire 65mm orange 0,75mm ²	1
40028773	Wire 340mm orange 0,75mm ²	6
40028774	Wire 255mm 1mm ² black	3
40028779	Wire 255mm 1mm ² blue	1
40031093	eAir main board	1
40029985	eAir main board connectors	1
40029195	Power supply Tufvassons PSLR24	1
40028788	Ground wire 100mm	1
40029647	Automation base	1
40029344	Terminal package	1
	Components	
40029346	Connector NAC 31S.W	1
40028768	Adapter	1
40029530	Adapter	1
40030100	Cable sealing VET 5-7	5
40030101	Cable sealing VET 7-10	7
40028783	Fan power cable	1
40028785	Fan signal cable	1
40029167	EDA temperature sensor 1700mm	2
40029166	EDA temperature sensor 1100mm	1
40029165	EDA temperature sensor 850mm	1
40029224	Humidity/temperature sensor Amphenol 600mm	1
40029982	WaGo 221-415	1
40031530	Screw ZN 4,2x25	5
40028776	Wire 250mm black (main switch)	2
40028777	Wire 250mm blue (main switch)	2
40028774	Wire 255mm 1mm ² black	1
40031537	Washer 6798-A ZN M 4x8	1
40031489	Nut DIN 934/8 ZN M4	1
40030997	Cable tie 2,5x200mm	10
40028737	HRW motor package stepless DC	1
40028725	Rotor cable DC 60cm	1
40031114	eAir panel package	1
40034288	WiFi module package	1
	Manuals etc. (depends on model)	
	eAir installation manual	1
	eAir user manual	1
	eAir electrical diagrams	1

Notes: