

# Automation upgrade

## Pelican MCC -> eWind

### Warning!

**According to regulations, an ordinary electricity consumer is only allowed to perform some minor service tasks.**

**A list of the allowed tasks can be found at the Tukes home page (Finland) ([www.tukes.fi](http://www.tukes.fi)).**

Always make sure that the power supply is turned off before opening the service door.

Wait two minutes before beginning the maintenance work. The fans rotate for some time by themselves, and the heating element may be hot even if the power supply of the ventilation unit is switched off. Electrical housing may be opened only by a trained electrician.

**Electrical installations must comply with local regulations.**

**Continuously check and compare the electrical diagrams at the end  
of this instruction as the upgrade progresses!**

## Table of contents

|  |    |
|--|----|
| Upgrade.....                               | 3  |
| Electrical diagrams MCC (in Finnish) ..... | 24 |
| Electrical diagrams eWind .....            | 26 |
| Parts list eWind E.....                    | 30 |
| Parts list eWind W.....                    | 31 |
| Notes .....                                | 32 |

Open **the small door (1)** by pressing on it.



Disconnect **the power cord (2)**  
(+ other power supplies if available).



Open the service door by turning **the handle (3)**.

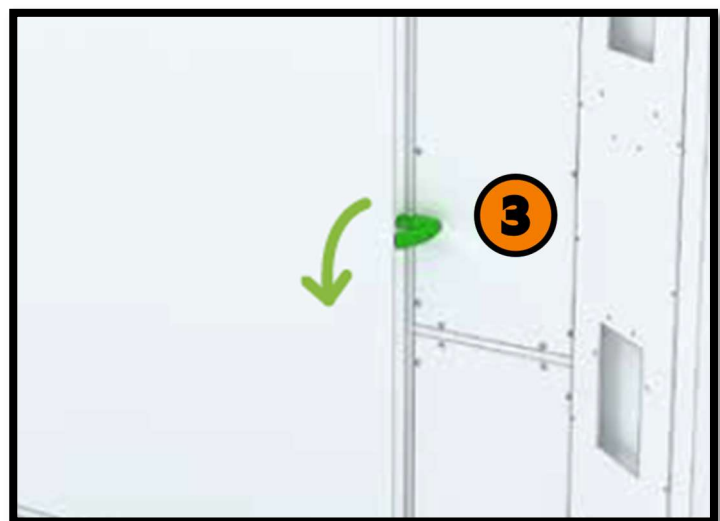

Remove **the cover to the electrical box (1)** and **the supply air fan chamber (1)** by removing the screws.

**NOTE! Ensure that no voltage is occurring in the electrical box before proceeding!**

Remove **the POP rivets** from **the cable rail (2)** by drilling, and remove the cover.

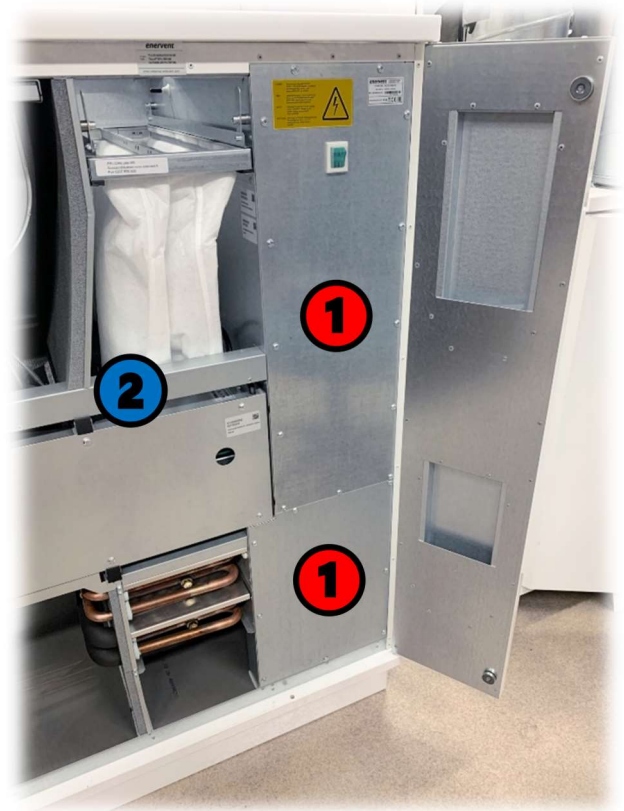

Remove **the filters (1)** by pulling.  
 Disconnect **the connectors (2)**.  
 Remove **the fans (3)**.  
 Remove **the HRW (4)** by pulling.  
 Disconnect and remove the main switch wires from **the terminals (5)**.

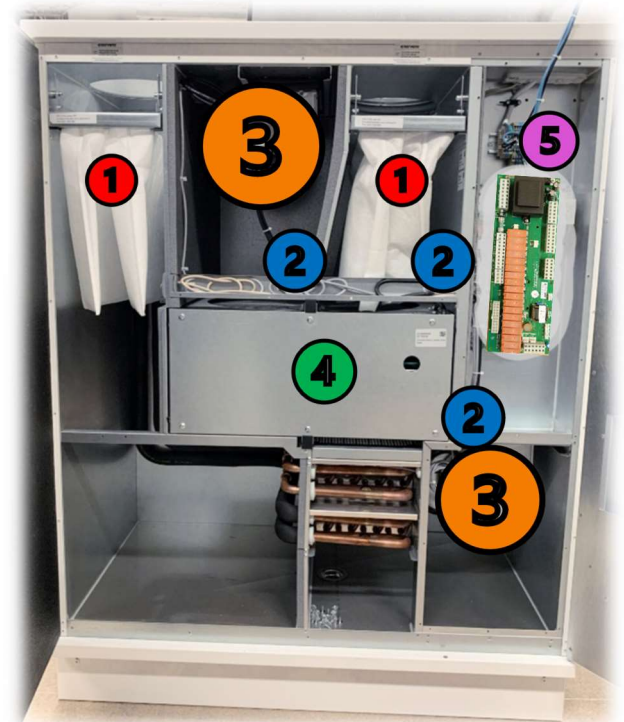

Disconnect **the power cord wires (1)**.

Disconnect and remove **the main switch wires (2)**.

Disconnect **all ground wires (3)** from the automation base ground point.

Disconnect **the rest of the wires (4)**.

Remove **the screws (5)** and remove the automation base including capacitors, transformer and possible other components.

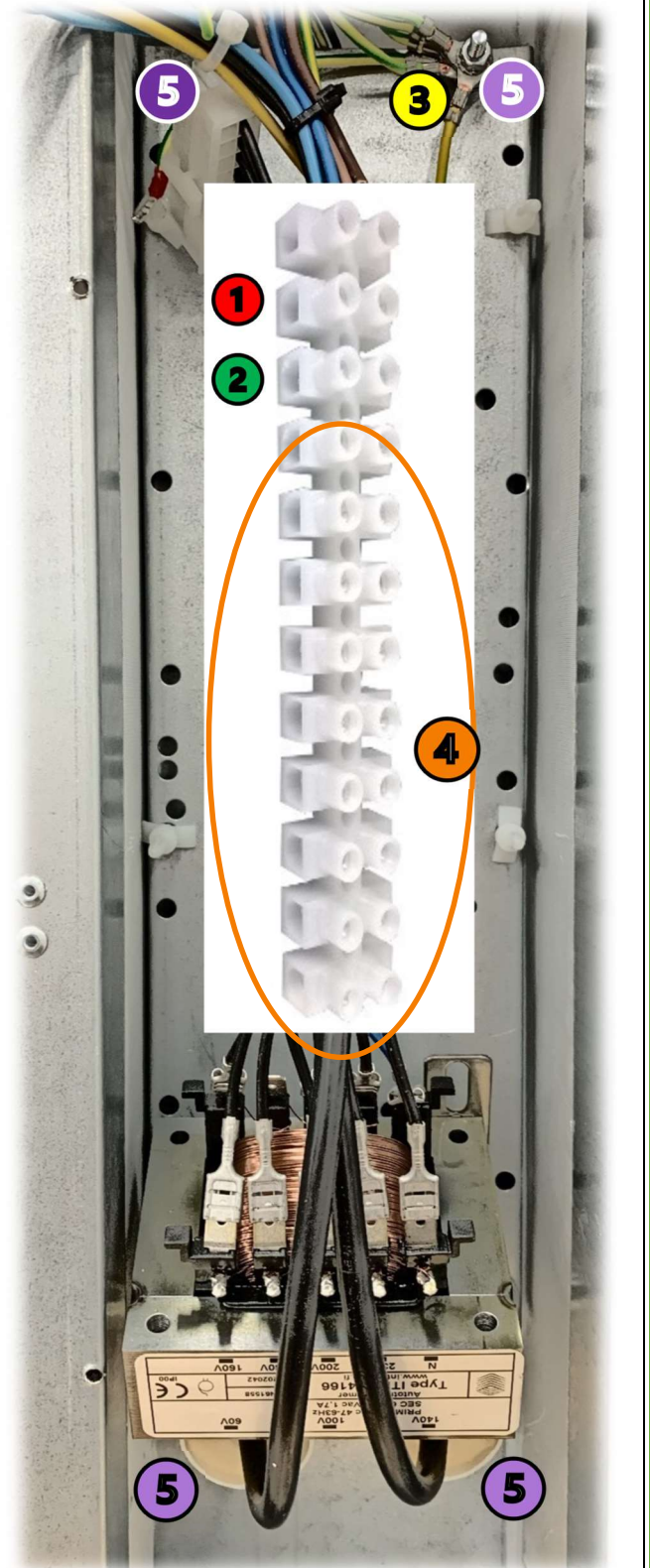

Remove the electrical after heater by pulling, along with the cables and the Pulser controller including sensors, connected to **the electrical after heater (1)**.  
*Ignore if no after heater installed.*

or

Leave the **water coil after heater (1)** installed, but disconnect and remove any possible automation.  
*Ignore if no after heater installed.*

Remove the POP rivets from **the fan rails (2)** by drilling, and remove the rails (they are also glued to the frame).

Remove **the HRW- and the fan cables (3)**.

Install **the new extract air sensor (4)** (40029225) and attach it with cable ties (40030997) to the cross support.

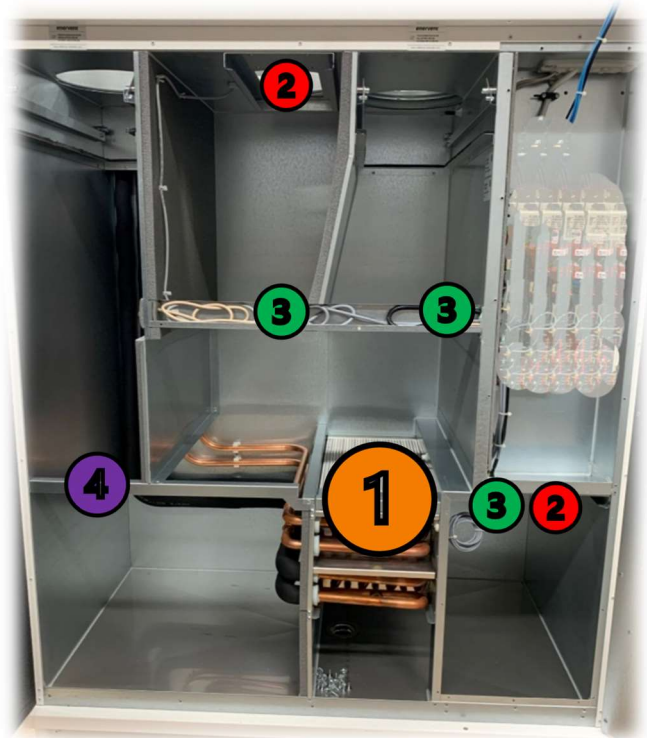

Cut a gap in the insulation and install the extract air sensor cable into **the gap (1)** and through the cable rail into the electrical box.



Install **the new fan rails (1)**  
(10025837)

by:

- drilling new 3,2mm holes for **the new POP-rivets (40031559)**.
- placing sealant between the frame and the fan rails.  
*ex. Würth silicone sealant.*
- attaching the new fan rails to the frame with **the new POP-rivets (40031559)**.

Drill two 18mm holes in the frame (where the old fan cables were attached (if needed), install **new cable sealings (40030101)** and install **the new fan cables (2)** (40028782, 40028783, 40028784, 40028785).

Drill a 18mm hole (where the old HRW cable were attached), install a new cable sealing (40030101) and install **the new HRW cable (3)** (40028725).

Install the cables in **the electrical box (4)**.

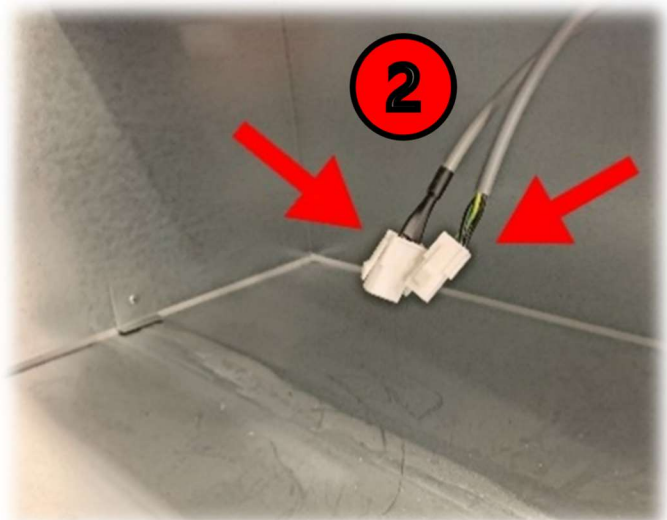
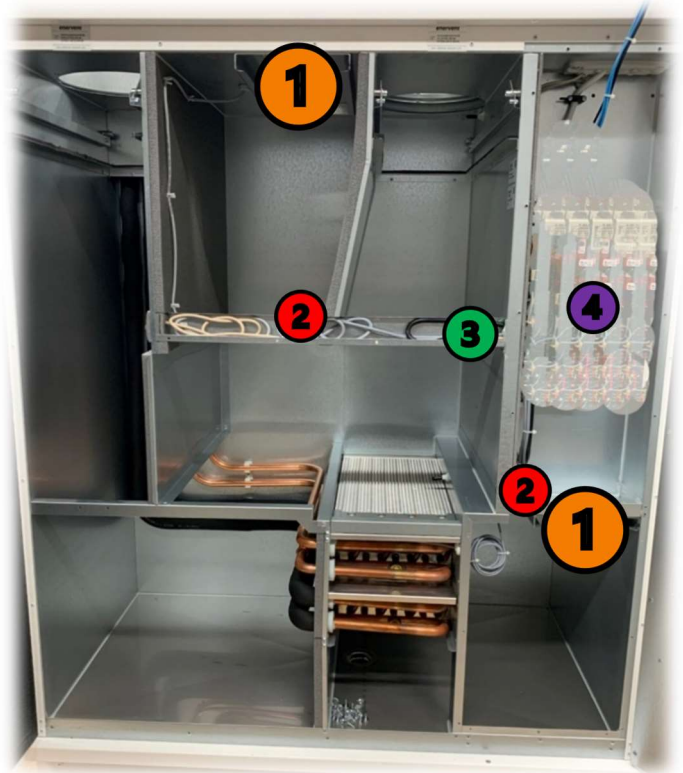





Drill a 16mm hole in **the outside air duct (1)**, install a new cable sealing (40030100) and install **the new outside air sensor (1) (1700mm)** (40029167) into the duct. Mark the sensor **"TE01"** on the connector in the other end and install it in **the electrical box (2)** through **the cable sealing in the frame (3)**.

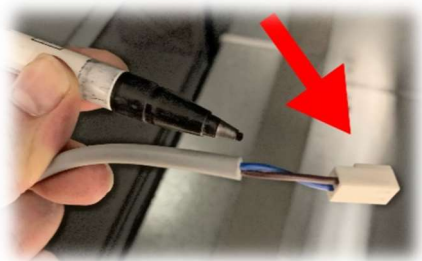
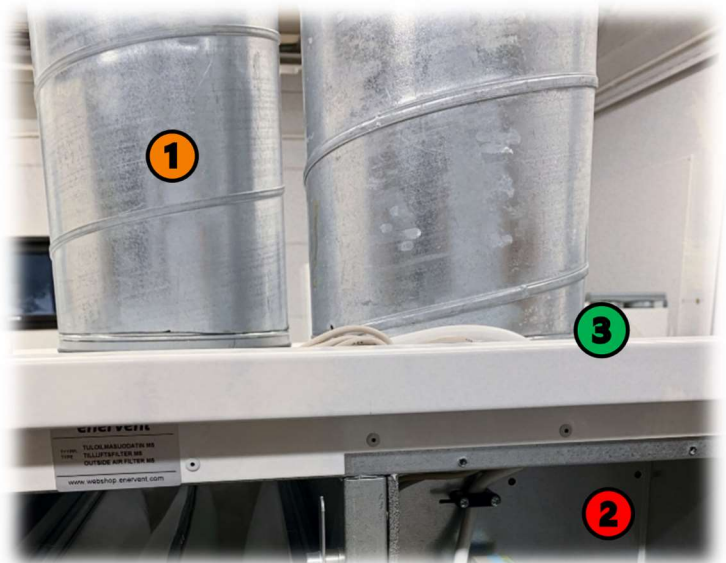

Install **the new HRW-supply air sensor (4) (850mm)** (40029165) and mark it **"TE05"** on the connector in the other end.

Install **the new supply air sensor (5) (500mm)** (40029230) and mark it **"TE10"** on the connector in the other end.

Install **the new waste air sensor (6) (1700mm)** (40029167) and mark it **"TE32"** on the connector in the other end.

If the unit has a water coil after heater installed; install **the new return water sensor (7) (40029228)** on the upper pipe of the water coil and isolate it from surrounding air.

Install the sensor cables in **the electrical box (2)**.

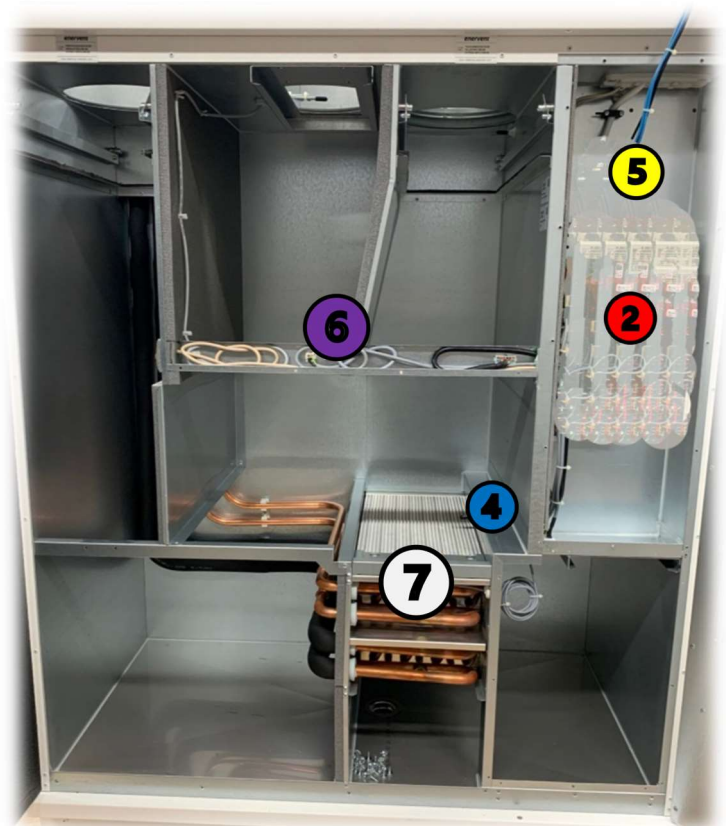

If the unit had an electrical after heater installed; install **the new electrical after heater (1)** (10023263) in its place and install the cables in **the electrical box (2)**.



Install **the new automation (3)** in the electrical box. Make sure no installed cable / sensor get stuck behind the automation base and that they are available in front of the main board.

Attach the automation base (40029647) to the electrical box with **four self tapping screws (4)** (40031530).



Connect **the main power cable to the terminals (1)**.

L: Brown

GND: Green/yellow

N: Blue

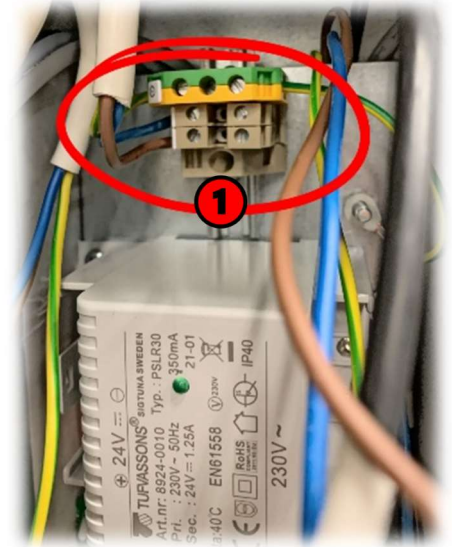

Install **the connection terminals (2)** (40029982).  
One for "L" and one for "N".



Connect **one pair of the wires with flat connectors** (40028820, 40028819) **to the connection terminals (1)** (40029982).

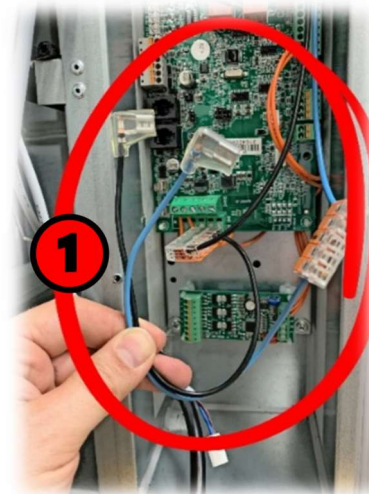

Connect **all ground wires** to **the automation base ground point (1)**.  
Supply air fan, extract air fan, (after heater), ground terminal.  
Tighten with **the nut** (40031489).

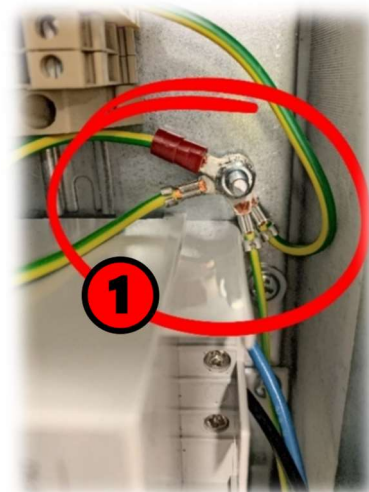

Connect **the blue wire** from the electrical after heater to **the blue connection terminal (2)**.  
*Ignore if no electrical after heater installed.*

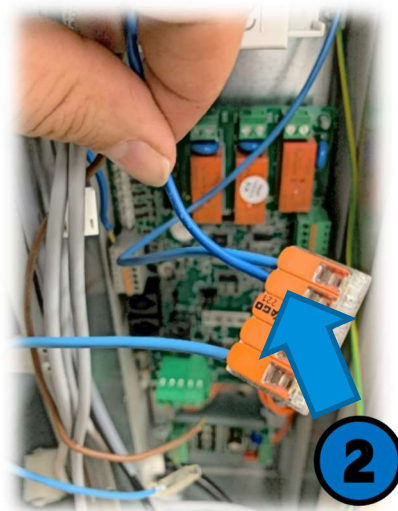

Connect **the black wire** (40028774) to **the black connection terminal (1)** (40029982).

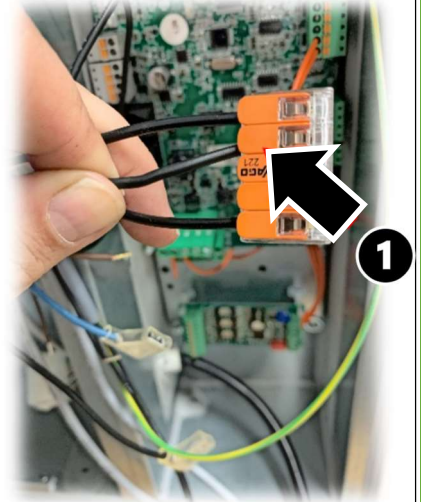

Connect **the same black wire** (40028774) to **"DO2" (2)** on the main board.



Connect **the brown wire** from the electrical after heater to **"DO2" (2)**.  
*If there is a water coil after heater installed, the circulation pump power wire (L) would be connected here.*



Connect **the wires marked "2"** in the fan power cables (40028782, 40028783) to **the blue connection terminal (2)** (40029982).



Connect **the wires marked "1"** in the fan power cables (40028782, 40028783) to **the black connection terminal (1)** (40029982).



**Power wires connected (1).**

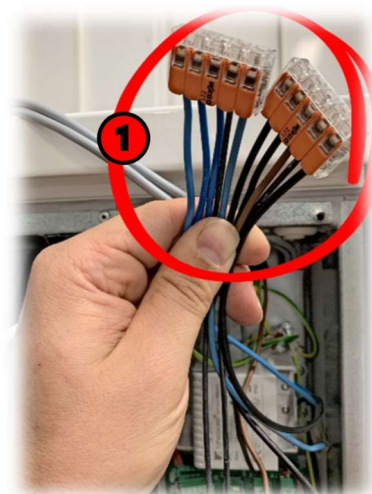

Connect **the extract air sensor (2)** (40029225) to the main board (X29).



Connect **the sensors (3)** to the main board according to the markings.

- TE01: Outside air** (40029167)
- TE05: HRW supply air** (40029165)
- TE10: Supply air** (40029230)
- TE32: Waste air** (40029167)

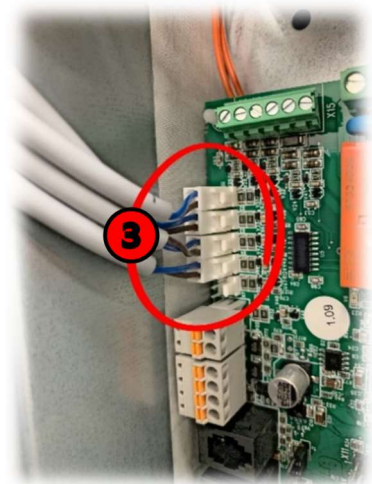

Connect **the wires from the supply air fan control cable (1)** (40028784) to the main board.

AO1: Brown  
GND: Black  
DI11: Gray

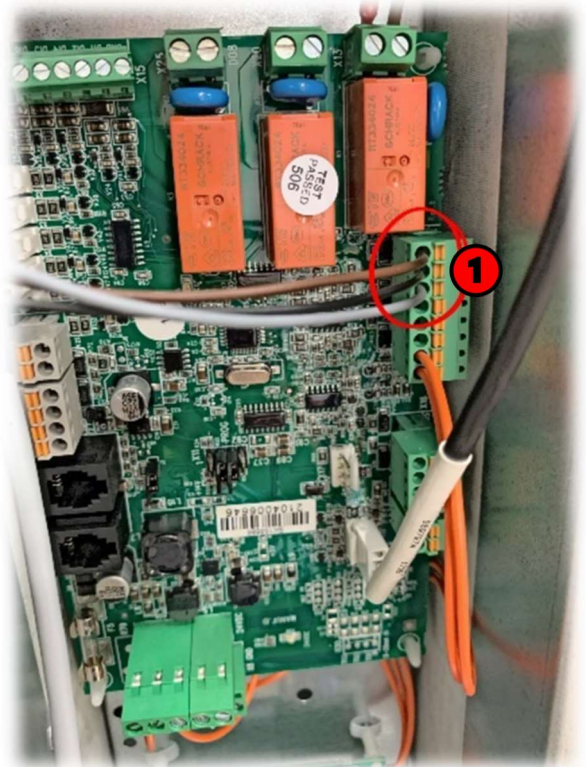

Connect **the wires from the extract air fan control cable (2)** (40028785) to the main board.

AO2: Brown  
GND: Black  
DI12: Gray

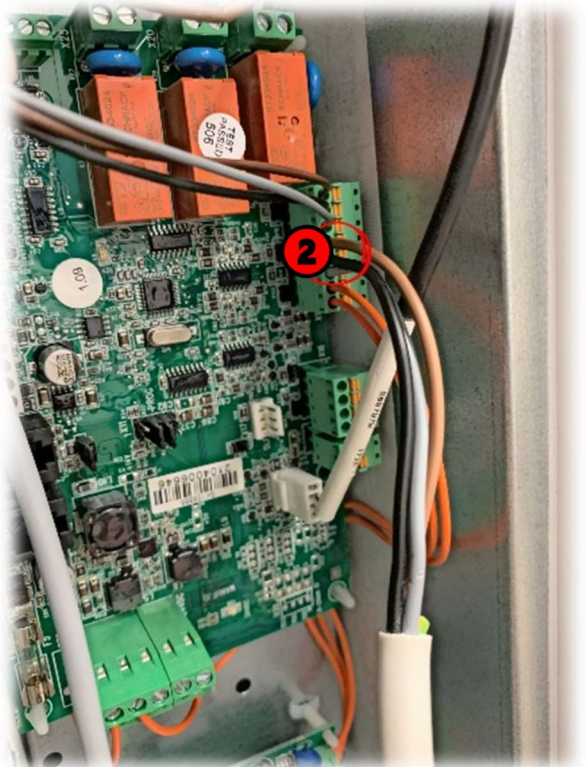



Release **the screw (1)** and attach **the ground wire (2)** from **the HRW cable** to the screw, along with **a washer**.

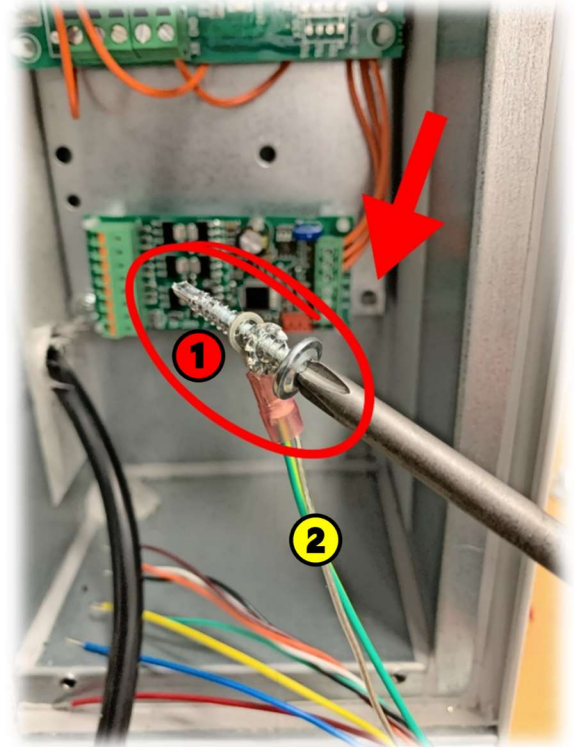

Reattach **the screw (1)** to the automation base.

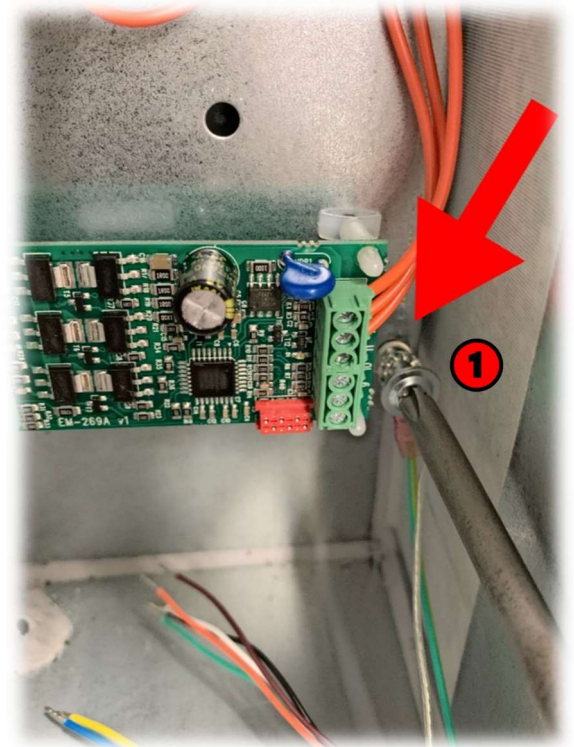

Connect **the wires from the HRW cable (40028725)** to the HRW control board (1).

1: Yellow

2: Red

3: Blue

4: White

5: Black

6: Brown

7: Green

8: Orange

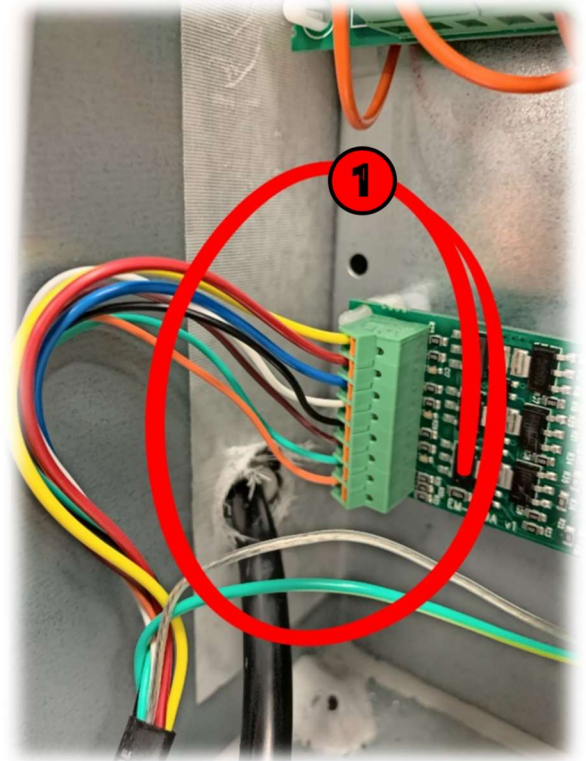

Connect **the after heater control cable (2)** to the main board (X17).

*Ignore if no electrical after heater installed.*

**Connect other components (for example return water sensor, actuator for water coil after heater or cooling coil) according to the electrical diagrams (pages 26-29).**

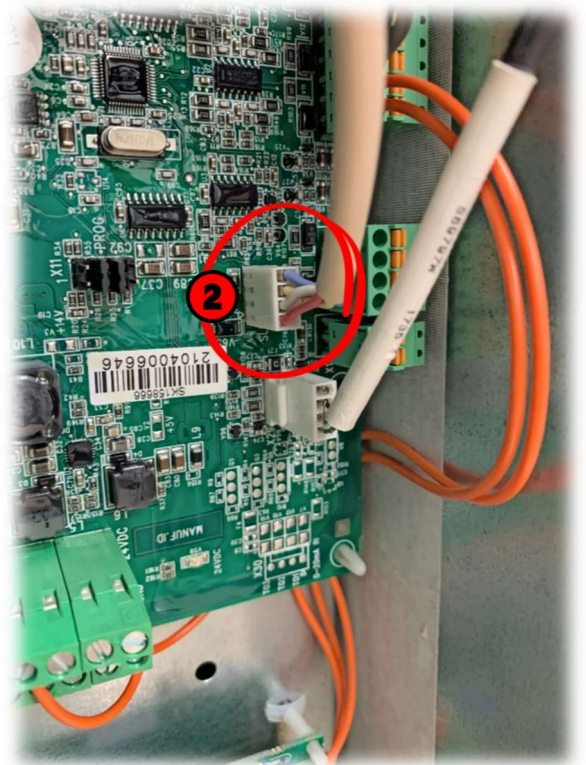

Connect **the wires with flat connectors (1, 2)** (40028820, 40028819) to **the main switch** from the **black & blue connection terminals (40029982)**.

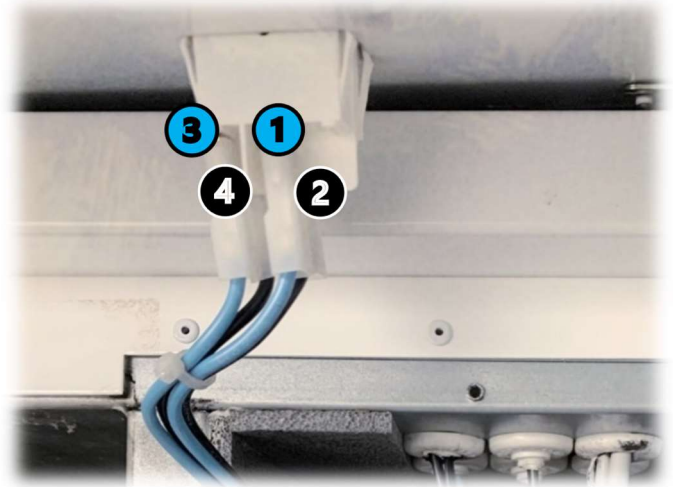

Connect **the other pair of wires with flat connectors (3, 4)** (40028820, 40028819) to **the main switch**, and to **the terminals (5)**.

L: Black (4)  
N: Blue (3)

Attach all cables and wires together with **cable ties (40030997)**.

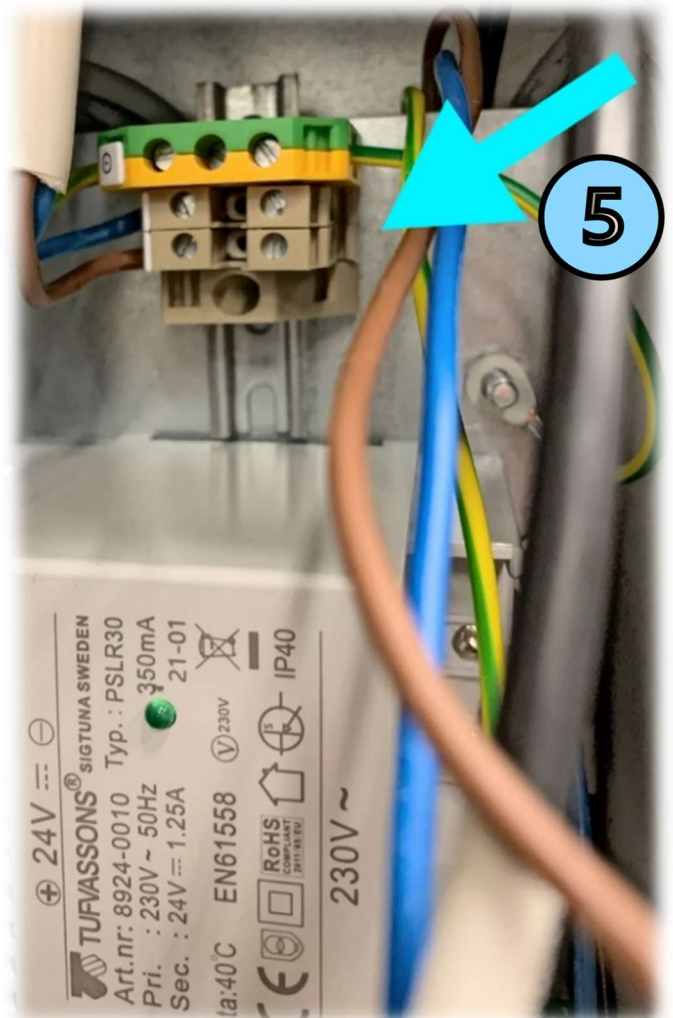

Install **the new fans (1)**  
(10023149),

and the locking parts  
(40031731).

Connect **the fan cables (2)** and attach  
them together with cable ties (40030997).

Install **the filters (3)**.

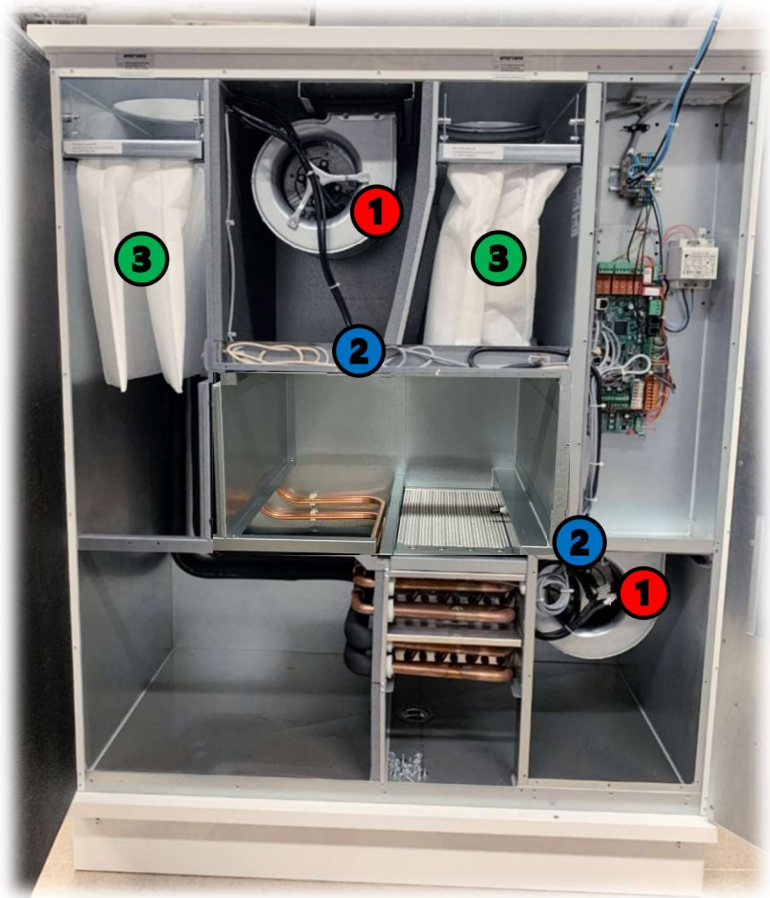

Remove **the screws (4)** from the HRW cover.



Remove **the belt (1)** from the wheel.  
Remove **the screws (2)** from the motor package.  
Remove **the ground wire (3)**.

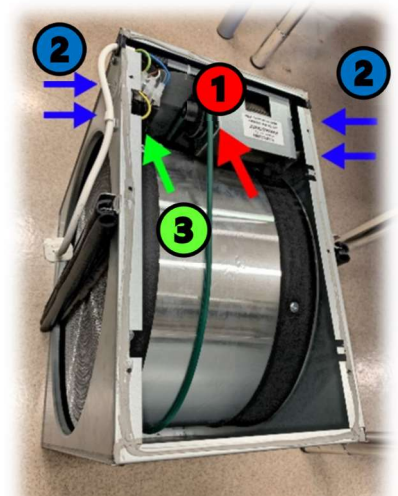

Remove the motor package.  
**Cut a gap (1)** for the new motor cable.  
Check that **the brush clips and the rubber sealings (2)** are unbroken and in place.

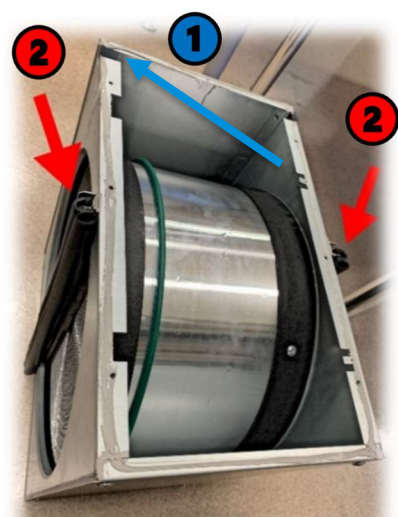

Install **the new motor package (1)** (40028738).  
Attach the cover with the screws.



Install **the HRW (1)** and connect it.

Connect **the new display cable (2)** to the main board through **the cable sealing in the frame (3)**.

The old display cable may also be used, but the joints has to be done carefully and in a proper way.

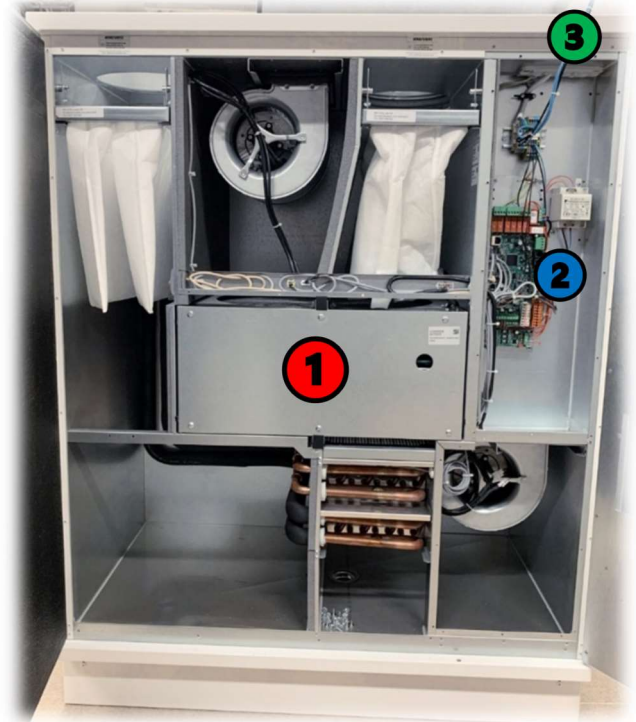

Disconnect and remove the old display. Install **the new display (4)** (40031115) in a desired place.



Install **the WiFi module (5)** (40034288).



Attach the cover to **the electrical box (1)**  
**and the supply air fan chamber (1)**.

Attach **the cover to the cable rail (2)**  
**with the new POP rivets (40031559)**.

Install **the new type plate sticker (3)**.

Close the service door.

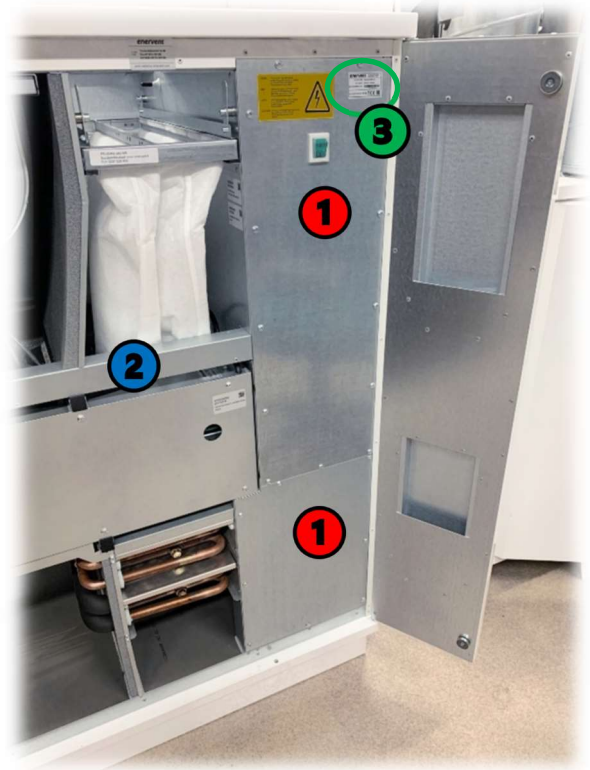

Turn on **the main switch (4)** and perform  
insulation and ground continuity test  
according to regulations.

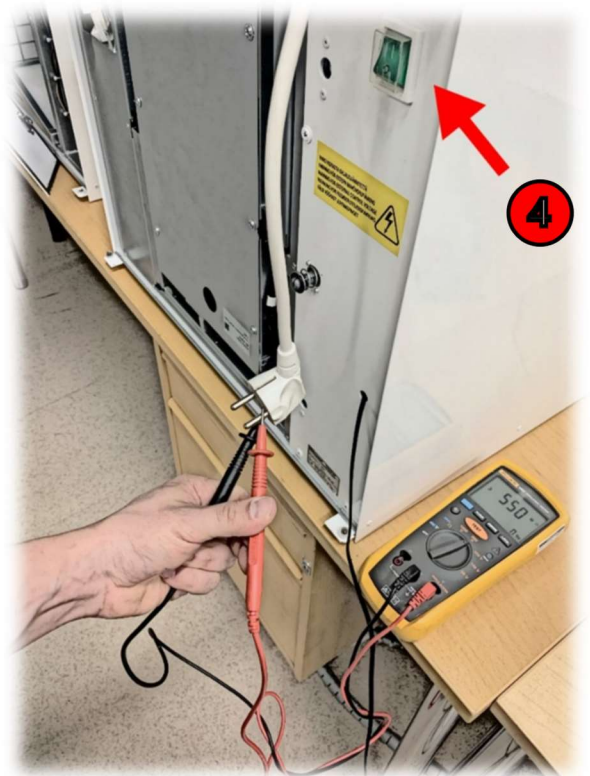

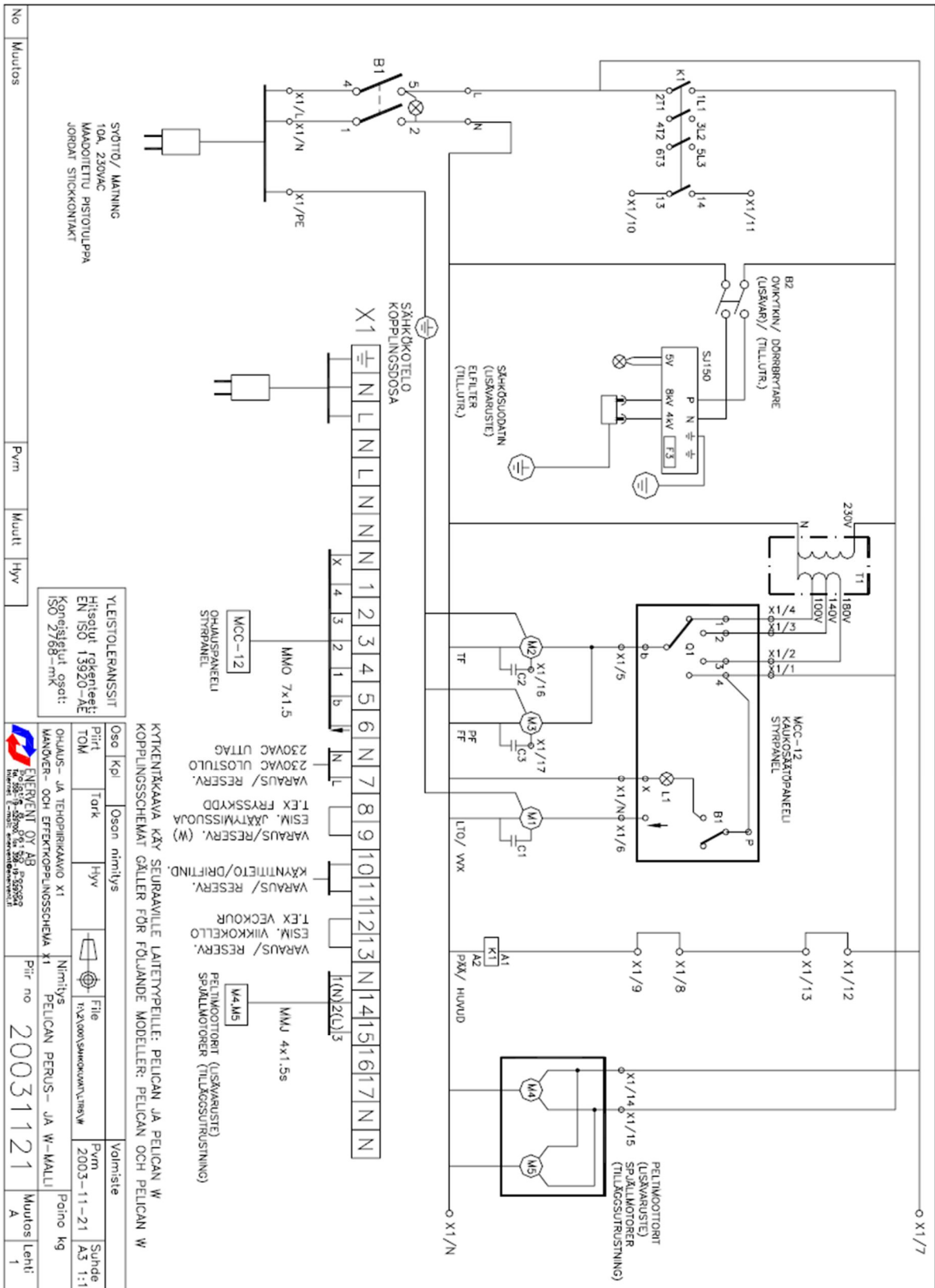



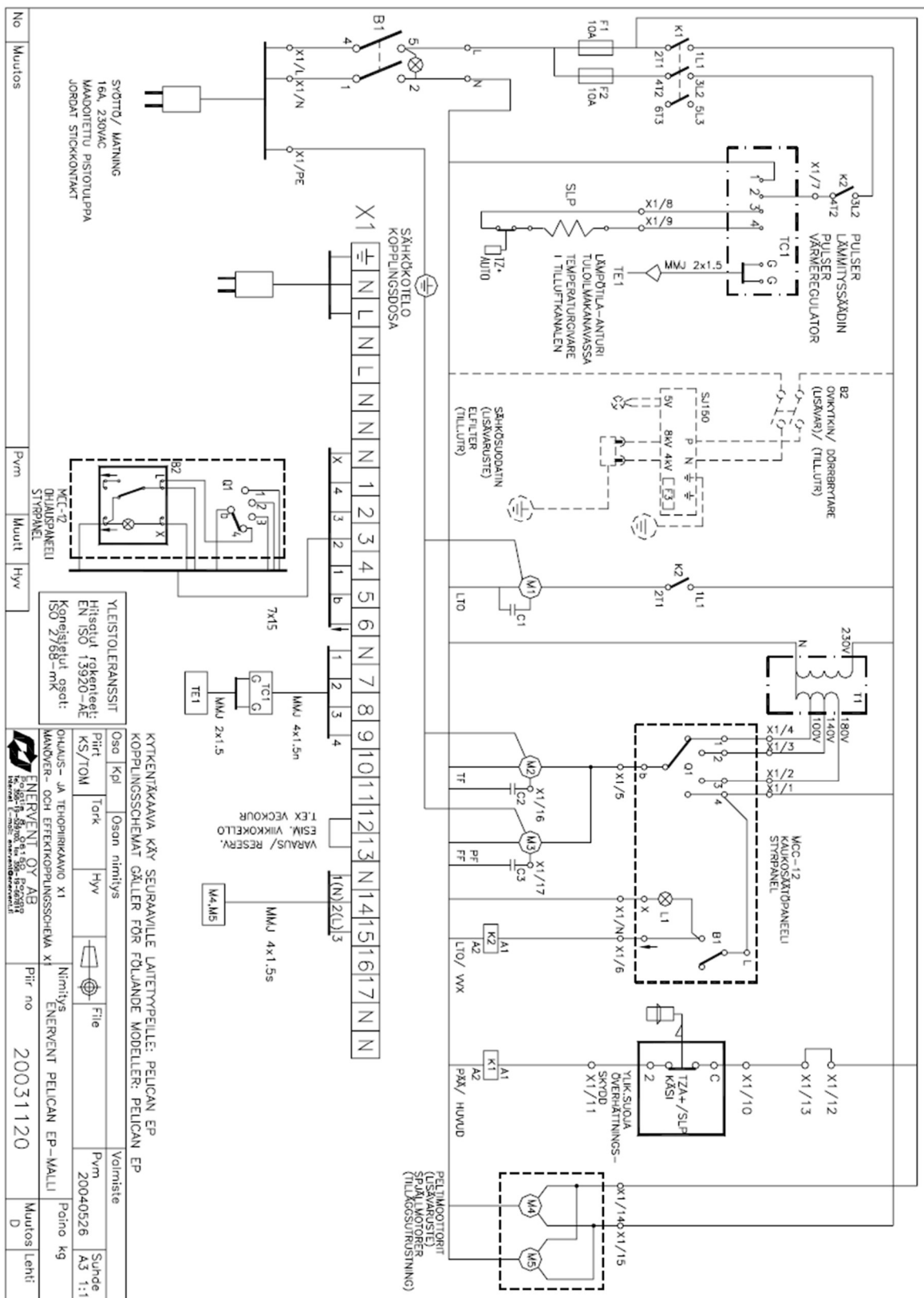

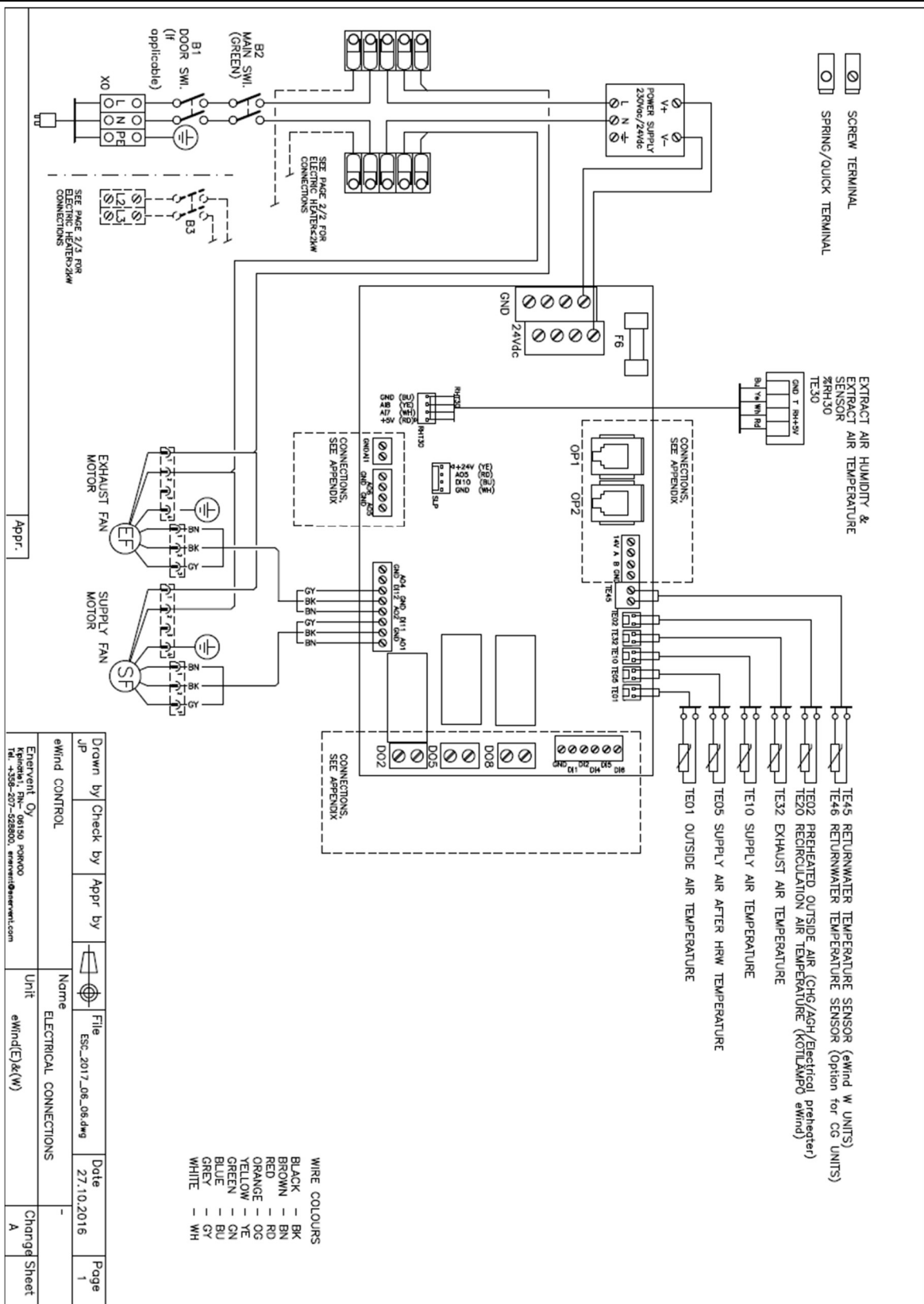

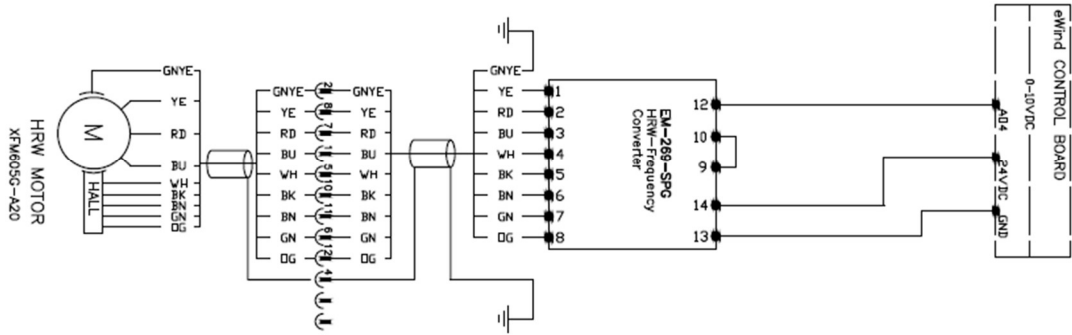

Appr.

- WIRE COLOURS
- BLACK — BK
  - BROWN — BN
  - RED — RD
  - ORANGE — OG
  - YELLOW — YE
  - GREEN — GN
  - BLUE — BU
  - GREY — GY
  - WHITE — WH

|  |          |         |                    |                           |       |
|--|----------|---------|--------------------|---------------------------|-------|
| Drawn by                                   | Check by | Appr by | File               | Date                      | Page  |
| JP   |          |         | ESC-2017_08_06.dwg | 02.12.2015                | 2     |
| eWind CONTROL                              |          |         | Name               |                           |       |
| HRW connections                            |          |         | Unit               | ELECTRICAL CONNECTIONS    |       |
| Enervent Oy                                |          |         | Unit               | UNIT INTERNAL CONNECTIONS |       |
| Kipinätie 1, FIN-06150 PORVOO              |          |         | Change             | A                         | Sheet |
| Tel. +358-20-528800, enervent@enervent.com |          |         |                    |                           | 1     |

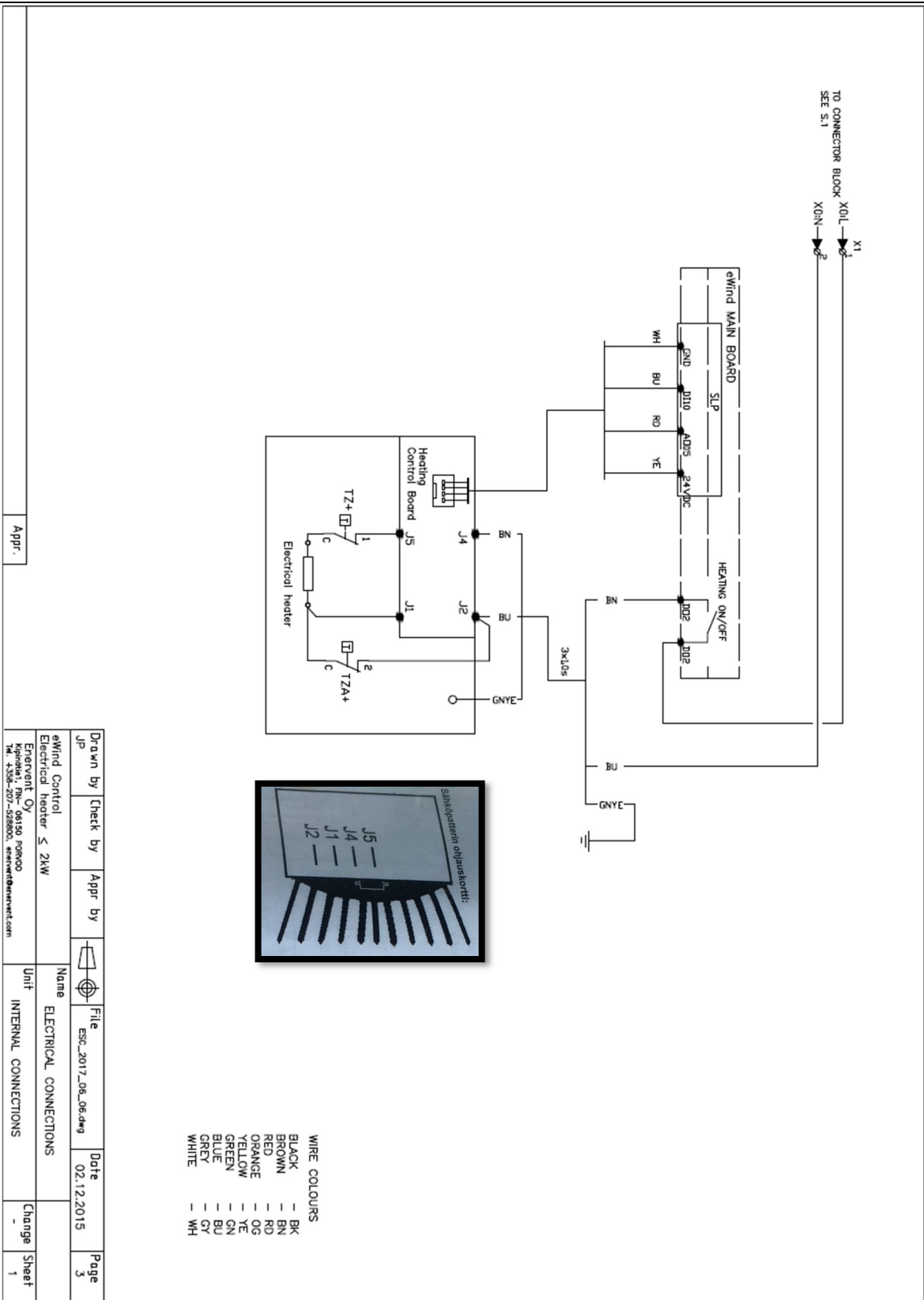

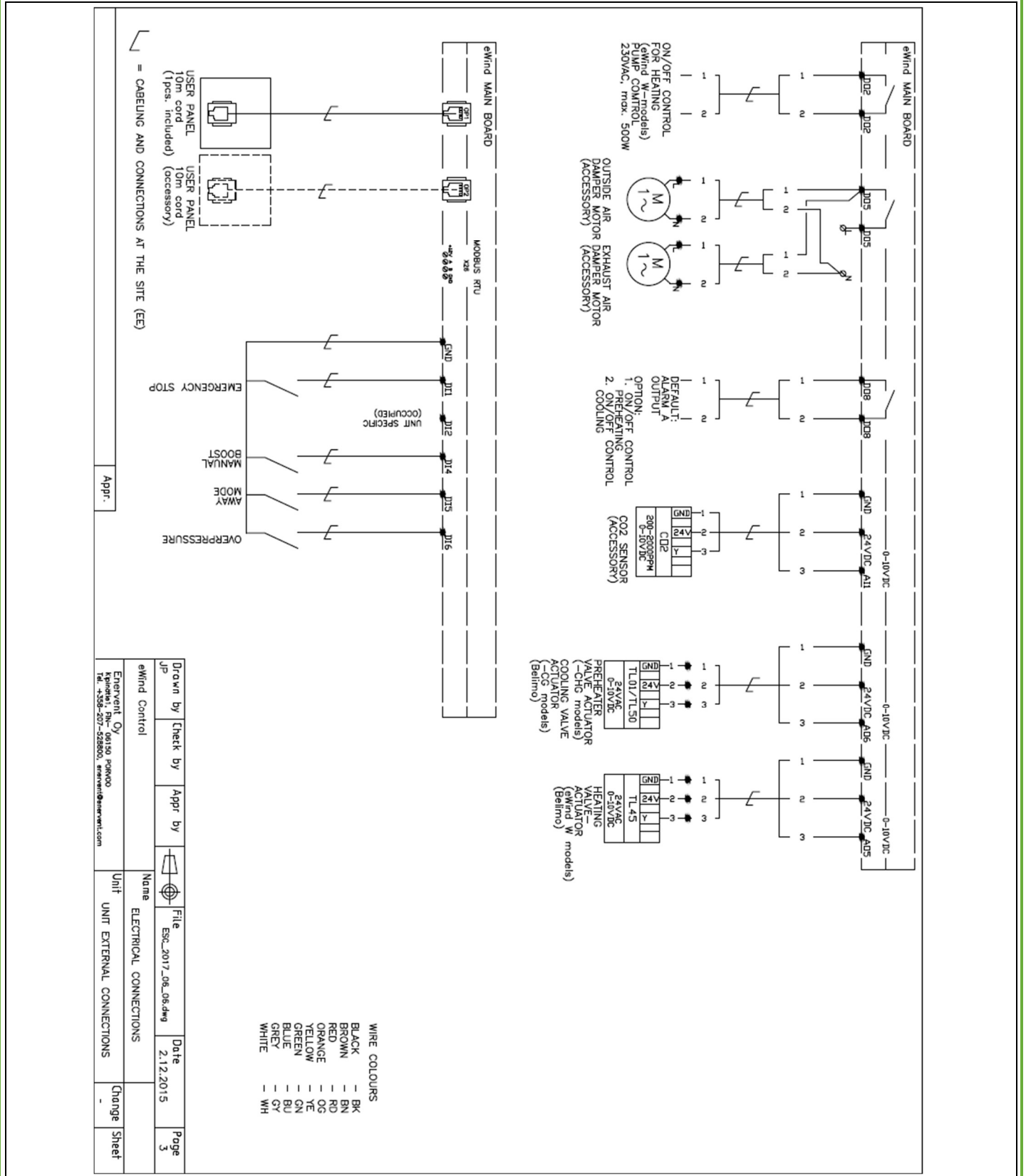

**MANDATORY PARTS**

|          |  |   |
|----------|--|---|
| 10024009 | CONTROL UPDATE KIT PELICAN ACE/ECE → EWIND E | 1 |
| 10023149 | FAN PACKAGE 170W                             | 2 |
| 10025837 | FAN RAIL PACKAGE                             | 1 |
| 10023263 | ELECTRICAL HEATER 2kW                        | 1 |

| <u>Code</u> | <u>Description</u>                           | <u>Pcs.</u> |
|-------------|--|-------------|
| 10024009    | CONTROL UPDATE KIT PELICAN ACE/ECE → EWIND E |             |

**Automation**

|          |                                       |   |
|----------|---------------------------------------|---|
| 40029189 | Control board EM-240-M                | 1 |
| 40030936 | PCB support KGLS-6S                   | 4 |
| 40030937 | PCB support LCBSM-6-01                | 4 |
| 40031695 | Screw DIN 7981 ZN 3,9x9,5             | 4 |
| 40031631 | Screw DIN 7985 ZN M4x20               | 1 |
| 40031537 | Washer 6798-A ZN M4x8                 | 3 |
| 40031489 | Nut DIN 934/8 ZN M4                   | 1 |
| 40028772 | Wire 65mm orange 0,75mm <sup>2</sup>  | 1 |
| 40028773 | Wire 340mm orange 0,75mm <sup>2</sup> | 5 |
| 40028774 | Wire 255mm 1mm <sup>2</sup> black     | 1 |
| 40028779 | Wire 255mm 1mm <sup>2</sup> blue      | 1 |
| 40031094 | eWind main board                      | 1 |
| 40029195 | Power supply Tufvassons PSLR24        | 1 |
| 40028788 | Ground wire 100mm                     | 1 |
| 40029341 | Terminal SL 4/15                      | 1 |
| 40029343 | Terminal ES 15 PA                     | 1 |
| 40029340 | Terminal SRK 2,5/15 PA                | 2 |
| 40029330 | PMC SB 5/50 So ERDE                   | 1 |
| 40029329 | PMC SB 5/50 So L                      | 1 |
| 40029327 | PMC SB 5/50 FW N                      | 1 |
| 40029647 | Automation base                       | 1 |

**Components**

|          |   |    |
|----------|---|----|
| 40030100 | Cable sealing VET 5-7                       | 2  |
| 40030101 | Cable sealing VET 7-10                      | 3  |
| 40028782 | Fan power cable supply air                  | 1  |
| 40028783 | Fan power cable extract air                 | 1  |
| 40028784 | Fan control cable supply air                | 1  |
| 40028785 | Fan control cable extract air               | 1  |
| 40029167 | EDA temperature sensor 1700mm               | 2  |
| 40029230 | EDA temperature sensor 500mm                | 1  |
| 40029165 | EDA temperature sensor 850mm                | 1  |
| 40029225 | Humidity/temperature sensor Amphenol 1800mm | 1  |
| 40029982 | WaGo 221-415                                | 2  |
| 40031530 | Screw ZN 4,2x25                             | 4  |
| 40028820 | Wire 600mm black (main switch)              | 2  |
| 40028819 | Wire 600mm blue (main switch)               | 2  |
| 40028774 | Wire 255mm 1mm <sup>2</sup> black           | 1  |
| 40031537 | Washer 6798-A ZN M4x8                       | 1  |
| 40031489 | Nut DIN 934/8 ZN M4                         | 1  |
| 40030997 | Cable tie 2,5x200mm                         | 10 |
| 40031559 | POP-rivet Multigrip 3,2x9                   | 20 |
| 40028738 | HRW motor package stepless DC               | 1  |
| 40031115 | eWind panel package                         | 1  |
| 40028725 | Rotor cable DC 60cm                         | 1  |
| 40034288 | WiFi module package                         | 1  |

**Manuals etc. (depends on model)**

|                           |   |
|---------------------------|---|
| eWind installation manual | 1 |
| eWind user manual         | 1 |
| eWind electrical diagrams | 1 |

**MANDATORY PARTS**

|          |  |   |
|----------|--|---|
| 10024008 | CONTROL UPDATE KIT PELICAN ACW/ECW → EWIND W | 1 |
| 10023149 | FAN PACKAGE 170W                             | 2 |
| 10025837 | FAN RAIL PACKAGE                             | 1 |

| <u>Code</u> | <u>Description</u>                           | <u>Pcs.</u> |
|-------------|--|-------------|
| 10024008    | CONTROL UPDATE KIT PELICAN ACW/ECW → EWIND W |             |

**Automation**

|          |                                       |   |
|----------|---------------------------------------|---|
| 40029189 | Control board EM-240-M                | 1 |
| 40030936 | PCB support KGLS-6S                   | 4 |
| 40030937 | PCB support LCBSM-6-01                | 4 |
| 40031695 | Screw DIN 7981 ZN 3,9x9,5             | 4 |
| 40031631 | Screw DIN 7985 ZN M4x20               | 1 |
| 40031537 | Washer 6798-A ZN M4x8                 | 3 |
| 40031489 | Nut DIN 934/8 ZN M4                   | 1 |
| 40028772 | Wire 65mm orange 0,75mm <sup>2</sup>  | 1 |
| 40028773 | Wire 340mm orange 0,75mm <sup>2</sup> | 5 |
| 40028774 | Wire 255mm 1mm <sup>2</sup> black     | 1 |
| 40028779 | Wire 255mm 1mm <sup>2</sup> blue      | 1 |
| 40031094 | eWind main board                      | 1 |
| 40029195 | Power supply Tufvassons PSLR24        | 1 |
| 40028788 | Ground wire 100mm                     | 1 |
| 40029341 | Terminal SL 4/15                      | 1 |
| 40029343 | Terminal ES 15 PA                     | 1 |
| 40029340 | Terminal SRK 2,5/15 PA                | 2 |
| 40029330 | PMC SB 5/50 So ERDE                   | 1 |
| 40029329 | PMC SB 5/50 So L                      | 1 |
| 40029327 | PMC SB 5/50 FW N                      | 1 |
| 40029647 | Automation base                       | 1 |

**Components**

|          |   |    |
|----------|---|----|
| 40030100 | Cable sealing VET 5-7                       | 2  |
| 40030101 | Cable sealing VET 7-10                      | 3  |
| 40028782 | Fan power cable supply air                  | 1  |
| 40028783 | Fan power cable extract air                 | 1  |
| 40028784 | Fan control cable supply air                | 1  |
| 40028785 | Fan control cable extract air               | 1  |
| 40029167 | EDA temperature sensor 1700mm               | 2  |
| 40029230 | EDA temperature sensor 500mm                | 1  |
| 40029165 | EDA temperature sensor 850mm                | 1  |
| 40029225 | Humidity/temperature sensor Amphenol 1800mm | 1  |
| 40029228 | Return water sensor, surface                | 1  |
| 40031530 | Screw ZN 4,2x25                             | 4  |
| 40029982 | WaGo 2 21-415                               | 2  |
| 40028820 | Wire 600mm black (main switch)              | 2  |
| 40028819 | Wire 600mm blue (main switch)               | 2  |
| 40028774 | Wire 255mm 1mm <sup>2</sup> black           | 1  |
| 40031537 | Washer 6798-A ZN M4x8                       | 1  |
| 40031489 | Nut DIN 934/8 ZN M4                         | 1  |
| 40030997 | Cable tie 2,5x200mm                         | 10 |
| 40031559 | POP-rivet Multigrip 3,2x9                   | 20 |
| 40028738 | HRW motor package stepless DC               | 1  |
| 40028725 | Rotor cable DC 60cm                         | 1  |
| 40031115 | eWind panel package                         | 1  |
| 40034288 | WiFi module package                         | 1  |
| 40034505 | Valve actuator TR24-SR                      | 1  |

**Manuals etc. (depends on model)**

|                           |   |
|---------------------------|---|
| eWind installation manual | 1 |
| eWind user manual         | 1 |
| eWind electrical diagrams | 1 |

Notes: